

INSTALLATION & OPERATION MANUAL

Installation & Operation Manual

Controller Instruction (OCPAD series)

I Product Description

1. Product photo:



2. Installation instructions (in mm)

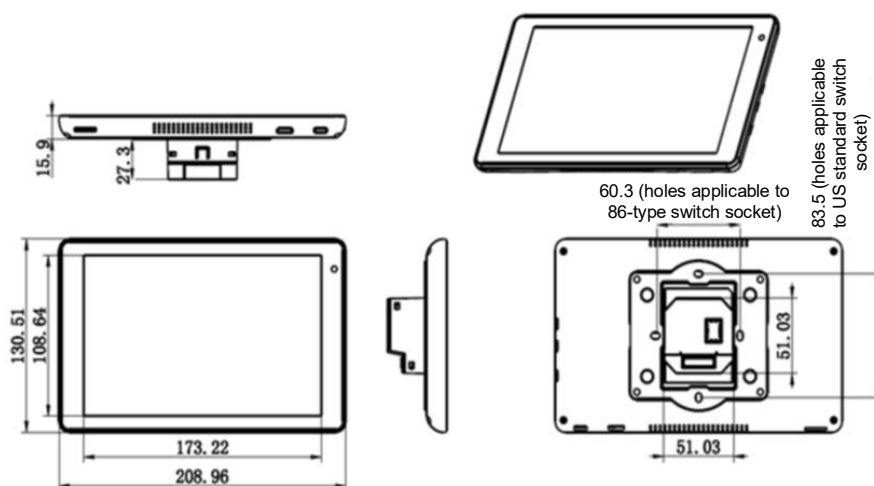

Wiring diagram

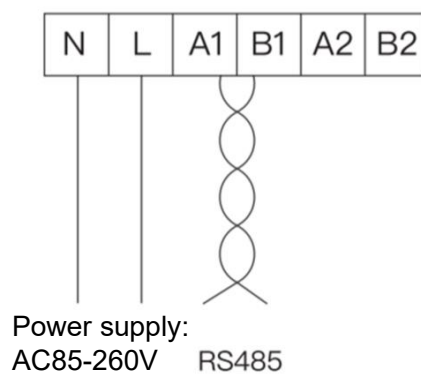

3. System composition

TICA Intelligent Management System applies to products of all platforms of TICA, including but not limited to the following: VRF unit, unitary unit, smart mini water machine, etc., with each 8-inch screen connected with one type of equipment or multiple types of equipment.

This intelligent management system involves an 8-inch centralized management controller and relevant Android/iOS mobile Apps.

Based on the logic of the 8-inch screen centralized management controller, the host is the centralized controller and the slave is the air conditioning unit. The communication diagram is as follows:

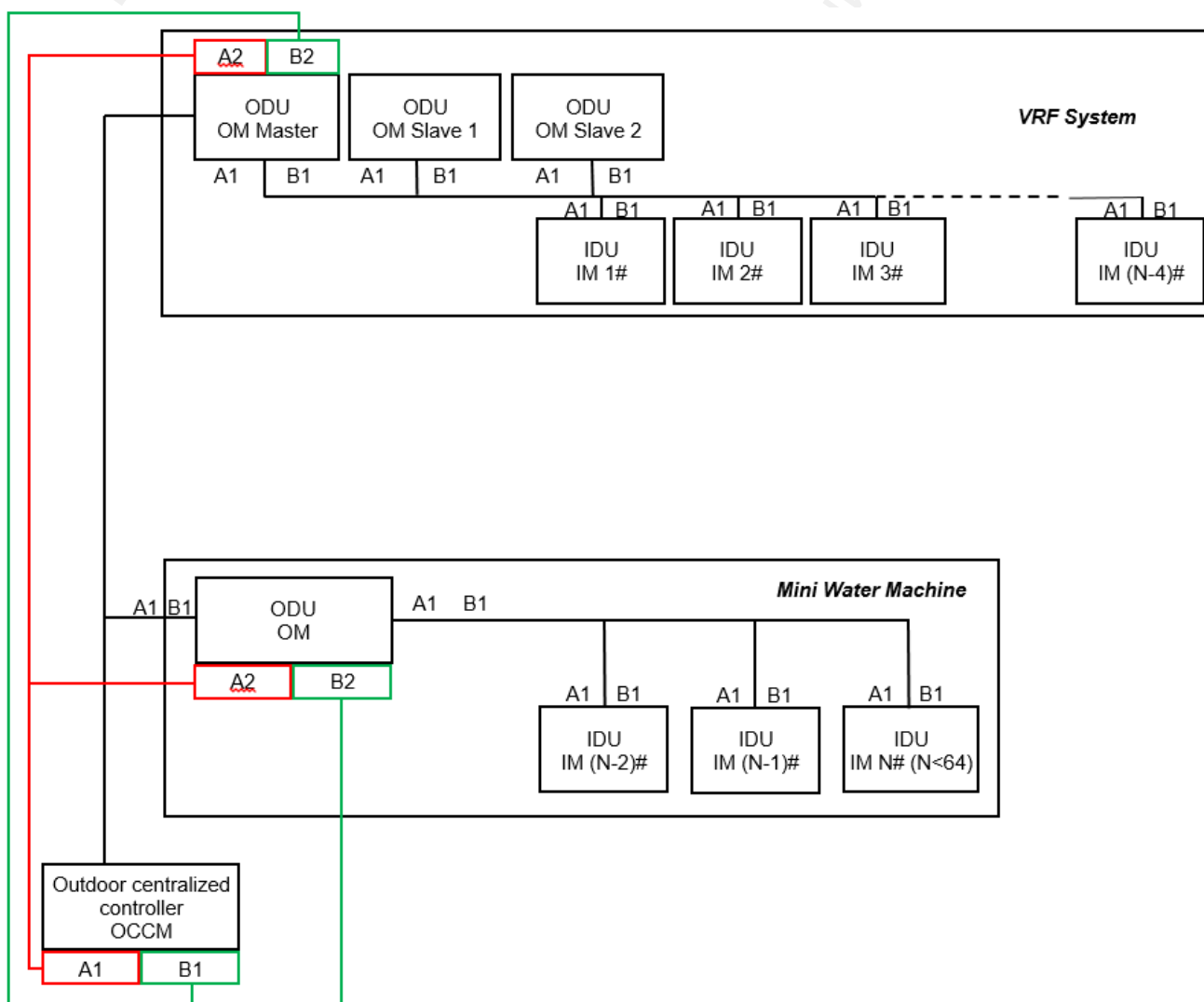

II Operational Instructions

1. Startup screen



2. Loading screen

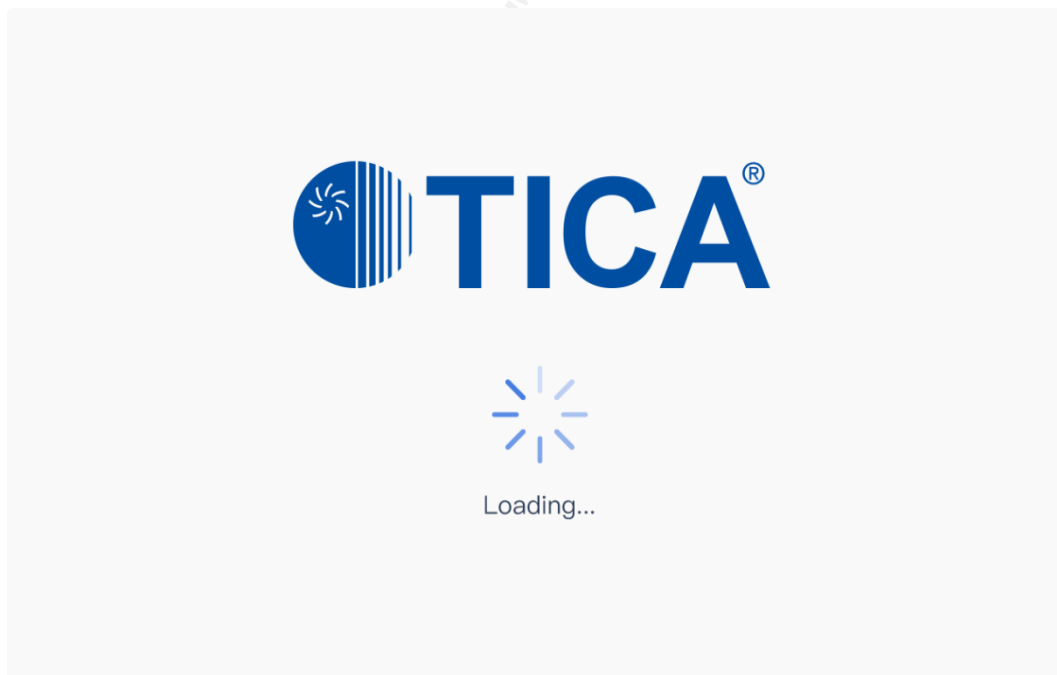

Overseas version: The loading screen displays no Chinese logo



Domestic version: The loading screen displays Chinese logo

Tip: After a language is selected in Settings, the system will display in the corresponding language version after it is restarted.

3. Homepage (functional module description)

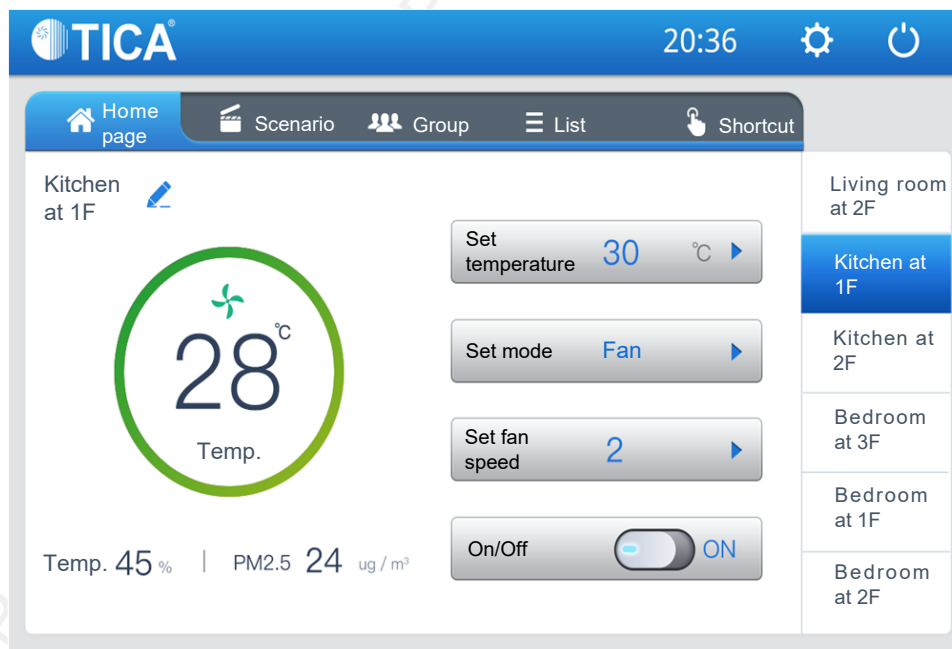











Homepage	Functional module	Remarks	User default permission
Status bar	Logo, date, switch button		OK
Parameter setting of IDU (room information)	Current temperature, humidity, PM2.5 display	The temperature displayed is the return air temperature of the IDU. Select to display either indoor temperature or set temperature in the added circle in the setting.	OK
	IDU mode setting	Display mode	
	IDU name display	Room name	
	IDU switch state	Power on/off	
	IDU temperature setting	The scope of setting varies with the model. See the agreement for details.	
	IDU fan speed setting	The arrangement of fan speeds is subject to the model, (speed 1-3, auto), (speed 1-7, auto for DC fan)	
	IDU name change	0-4 Chinese character(s), default room 1, 2...	
IDU one-tap setup (shortcut)	Room parameters: one-tap power on/off, one-tap temperature setting, one-tap fan speed and mode setting	Tap the relevant setting, and the prompt box for confirmation of setting all rooms is popped up. Simply tap to confirm the setting	OK

Homepage	Functional module	Remarks	User default permission
IDU group setting	1-8 groups are set	The mini water machine does not support group setting	OK
(IDU) list of rooms	List form of all IDUs: mode, temperature, fan speed, switch status		OK
Setting	Tap to enter application setting, general setting, advanced setting		OK, remove advanced setting
Off	Turn off the screen and it enters standby mode with black screen		OK

Notes:

- 
 The room name can be edited. Tap to pop up the edit box. The name may contain up to 1-4 Chinese characters. Default room X.
- Working mode and color change of middle temperature circle:

Mode	VRF/ unitary unit	Circle color variation
Cool		Blue circle
Heat		Red circle
Dry		Violet-blue circle

Mode	VRF/ unitary unit	Circle color variation
Fan		Green circle
Auto		Violet-blue circle
Mode	Mini water machine	Circle color variation
Fan coil cooling		Blue circle
Fan coil heating		Red circle
Floor heating		Red circle
Floor heating preservation		Red circle
Fan		Green circle
Floor heating + fan coil heating		Red circle

Note: By default, the temperature displayed in the circle is the indoor temperature, which is the air return temperature of the IDU. The temperature in the circle can be switched in "Setting" to either display "set temperature" or "indoor temperature".

- 3) Temperature, humidity and PM2.5 display. If the IDU has no humidity or PM2.5, the parameters are not shown. VRF unit has no humidity or PM2.5. See the agreement for details.
- 4) See the agreement for details of temperature setting and mode setting.
- 5) The arrangement of fan speeds is subject to the model, (speed 1-3, auto), (speed 1-7, auto for DC fan)
- 6) Power-on/off: the icon is blue at power-on and gray at power-off.
- 7) Room names are displayed on the right in order: Room 1, Room 2, Room 3...

3.1 Homepage – temperature setting

Click the arrow on the right of **Set temperature** to open the drop-down menu, slide it to set the temperature, and tap to save the setting and exit.

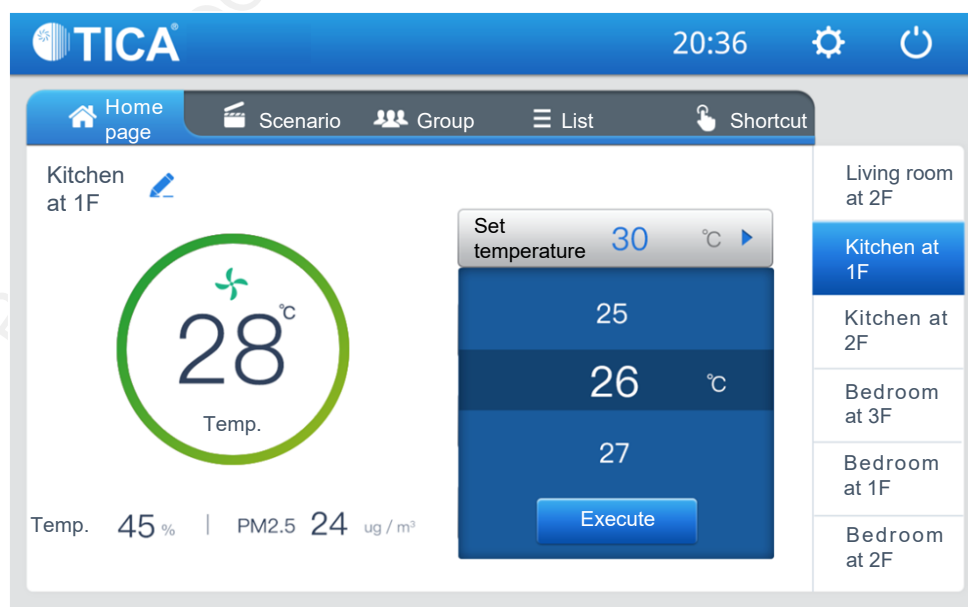

3.2 Homepage – mode setting

Tap the arrow on the right of **Set temperature - Cool** to open the drop-down menu for mode selection. The mode setting of the mini water machine is different from that of the unitary unit or VRF unit in that it can automatically identify the model to display corresponding mode setting. Select the corresponding mode and save the setting on the screen.





Note: Switch the mode if mode conflict is reported during touch screen centralized controlling!

4. Scenario

Tap the  icon on the main screen

Tap **+** to create a new scenario. Multiple scenarios can be created. The scenario can be applied to the IDU selected. You can select the group to include all IDUs in this group.



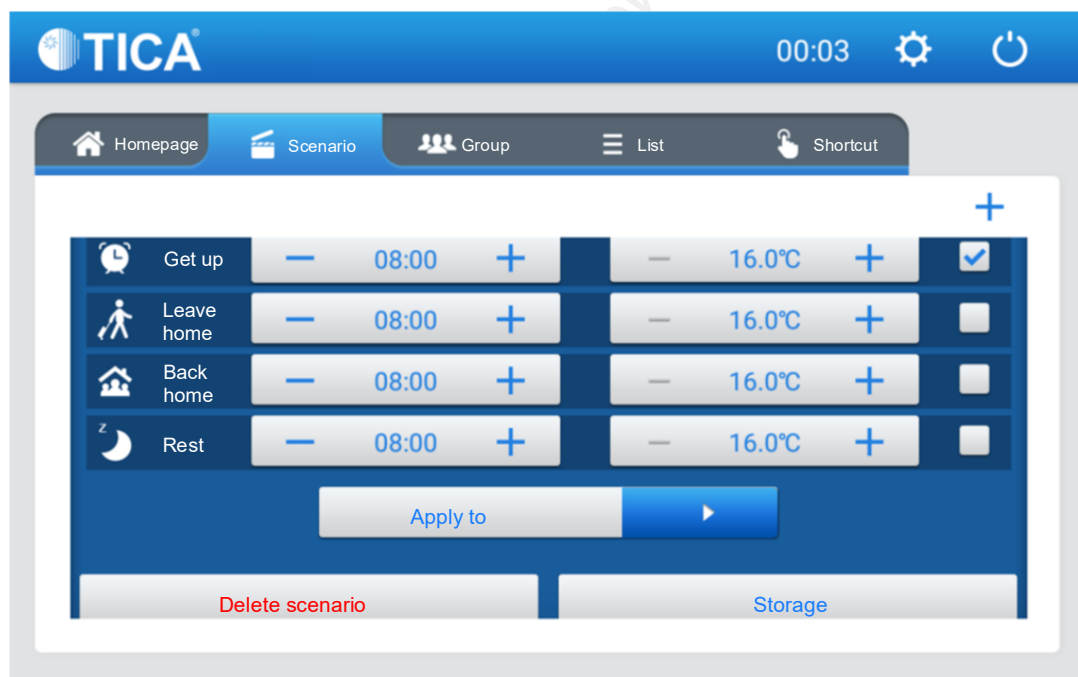

- ① After the scenario is created, tap  to set the current scenario. The scenario can be set for a total of 7 days from Monday to Sunday; there are 4 time periods for each day in which the target temperature can be set respectively. Select the applied group or IDU and save it. Slide down to set the value. After finishing the setup, tap  to fold the setting.
- ② Scenarios can be deleted.

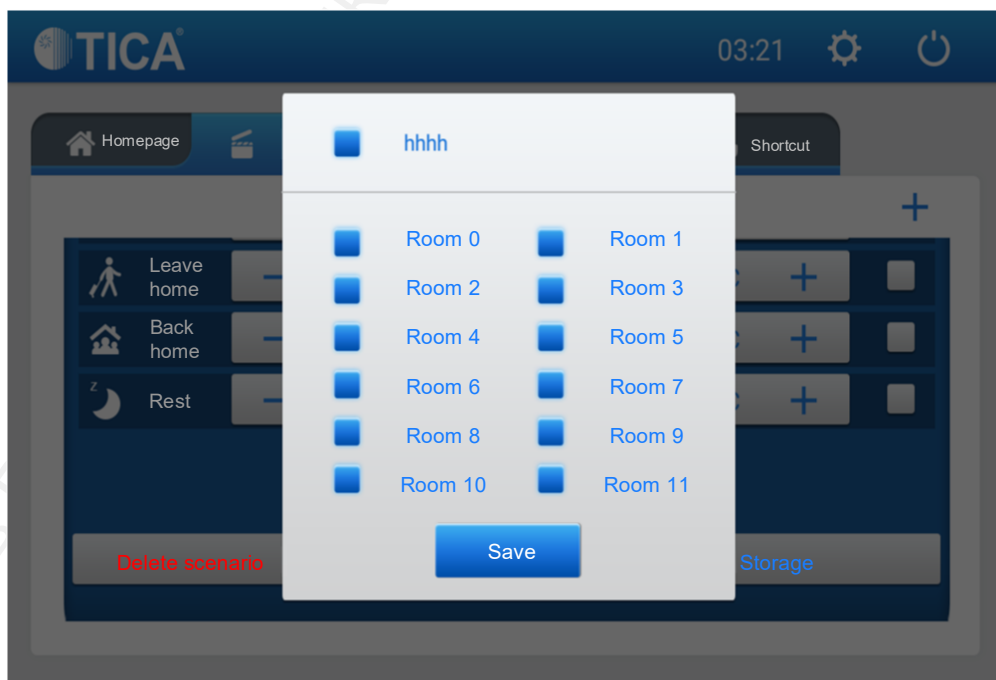

Further tap **Apply to** to select devices: select a group to include all IDUs in this group, or select individual IDU. Finally, tap **Save** to execute the scenario.



5. Group setting

- 1) Tap the Group icon  on the main screen to add groups, view IDU devices in groups, or delete groups. Default 1 group, tap  to pop up a window where you can check the details of the IDU in the group and delete the group.
- 2) Select the group to be set, and adjust the mode, fan speed, temperature, switch status within the group and deliver them. Tap **Execute** to deliver to the IDUs of corresponding group. For one time only.
- 3) Tap **+** to add and name groups. There is no IDU for the initial addition. The system prompts you to select the IDUs as group members in the setting.
- 4) Tap **View** in the group to view the list of IDUs in the group. Tap  to rename the group and tap  to delete the group

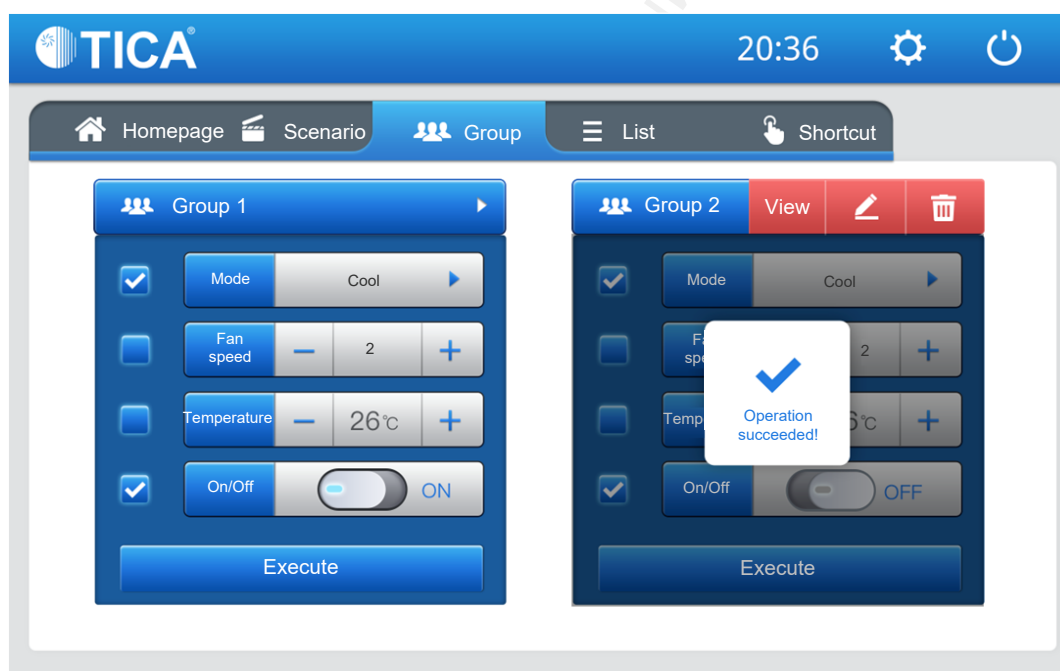
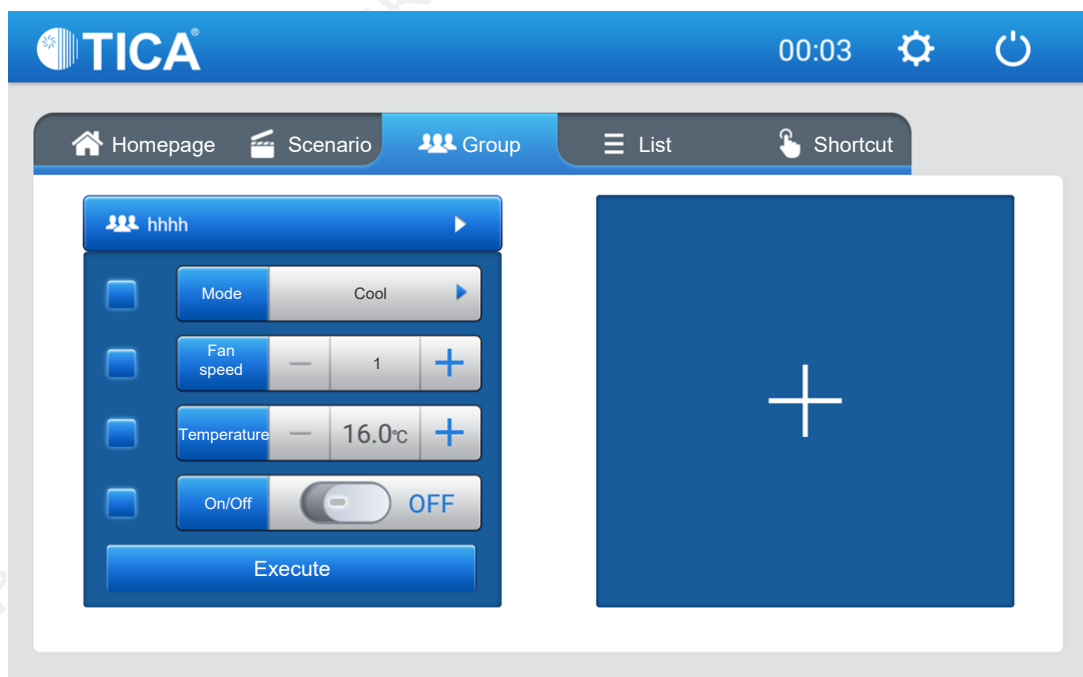

6. List of IDUs

Tap the List icon  on the main screen to enter the following screen where you can view the parameter status of all IDUs. Slide down to view all other rooms.

Tip: Green dot indicates that the IDU works normally in power-on mode, gray dot indicates the IDU is powered off, and the red dot indicates communication failure

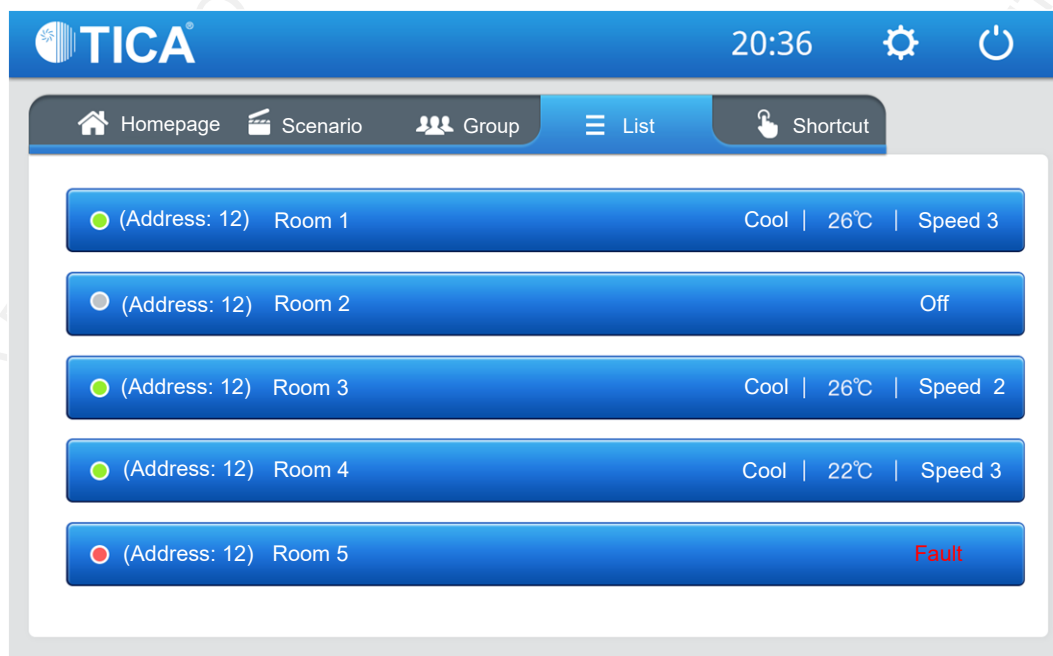

7. Shortcut operation

Tap the List icon  on the main screen to enter the following screen where you can switch on/off the IDU, set the temperature and fan speed of the IDU with only one tap. Tap **Execute** to deliver the instructions to all rooms.

Tip: One-tap-open and one-tap-close are radio, change it to a circle, select temperature and fan speed, and tap **Execute** to make it work.

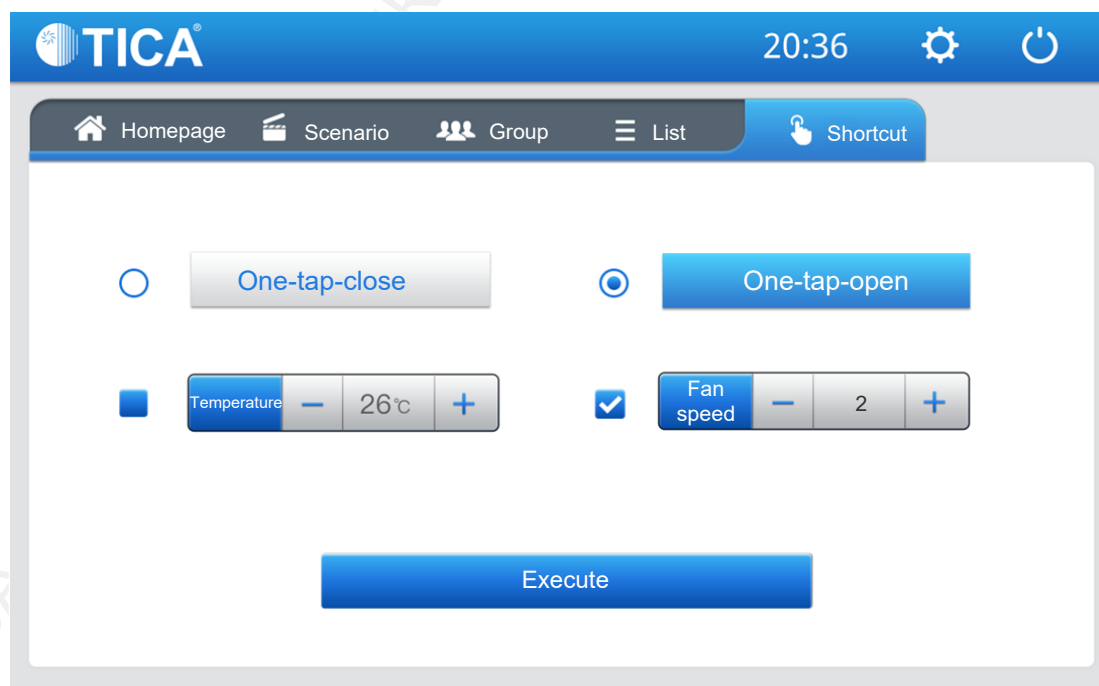

8. Basic setting

Tap the Setting icon  on the homepage to enter the page of detailed setting. The setting includes: **General setting**, **Application setting** and **Advanced setting**

8.1 General setting as follows: (Note: the secondary interface is not shown here)

- ① Device binding: Enter the interface to operate app network matching (see app operation instructions for details)
- ② Time setting: The local time can be set. If connected to Wi-Fi, the device automatically obtains the time from the Internet.
- ③ Brightness setting: The brightness and dormant time can be adjusted.
- ④ Language selection: Chinese/English; Chinese by default
- ⑤ Switchover of thermometric scale: Degrees Celsius/Fahrenheit
- ⑥ Service support: After-sale service information of the manufacturer or official WeChat QR code of the manufacturer etc.
- ⑦ Version information: Version information and upgrade reminder (The upgrade needs to be performed on the App. If A pop-up box for upgrade appears in case of new version.). Do not cut off the power supply during equipment upgrade.

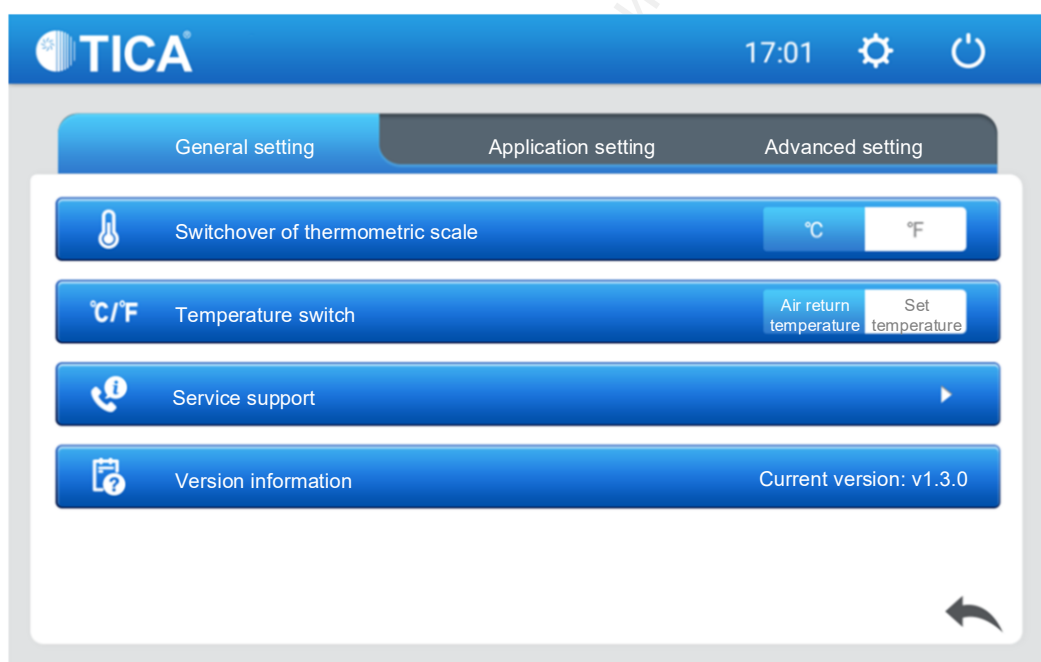
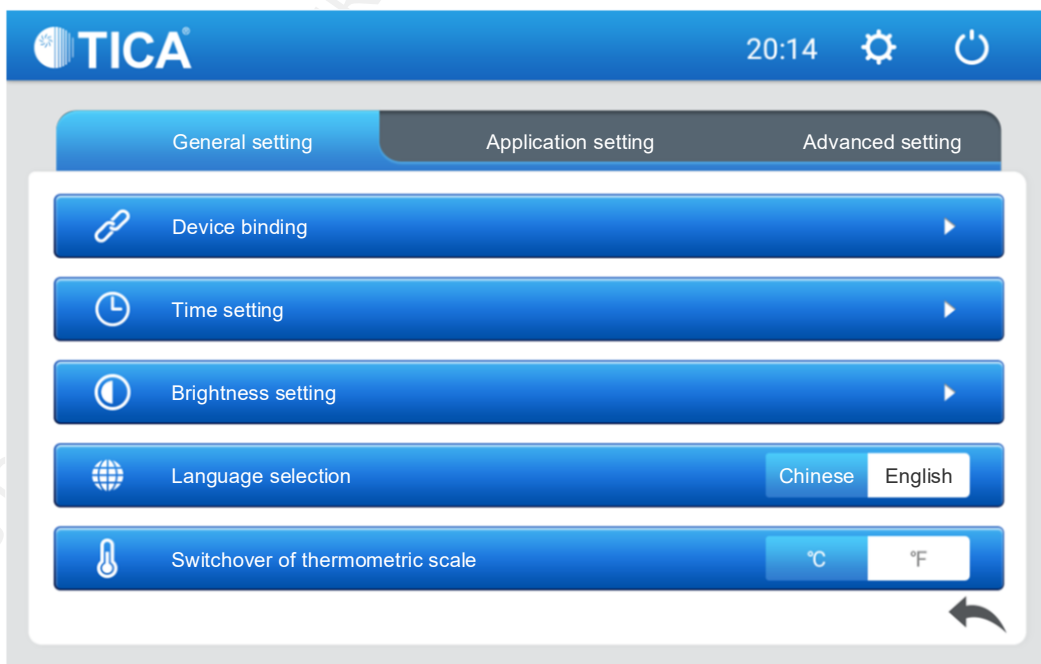

8.2 Brightness setting

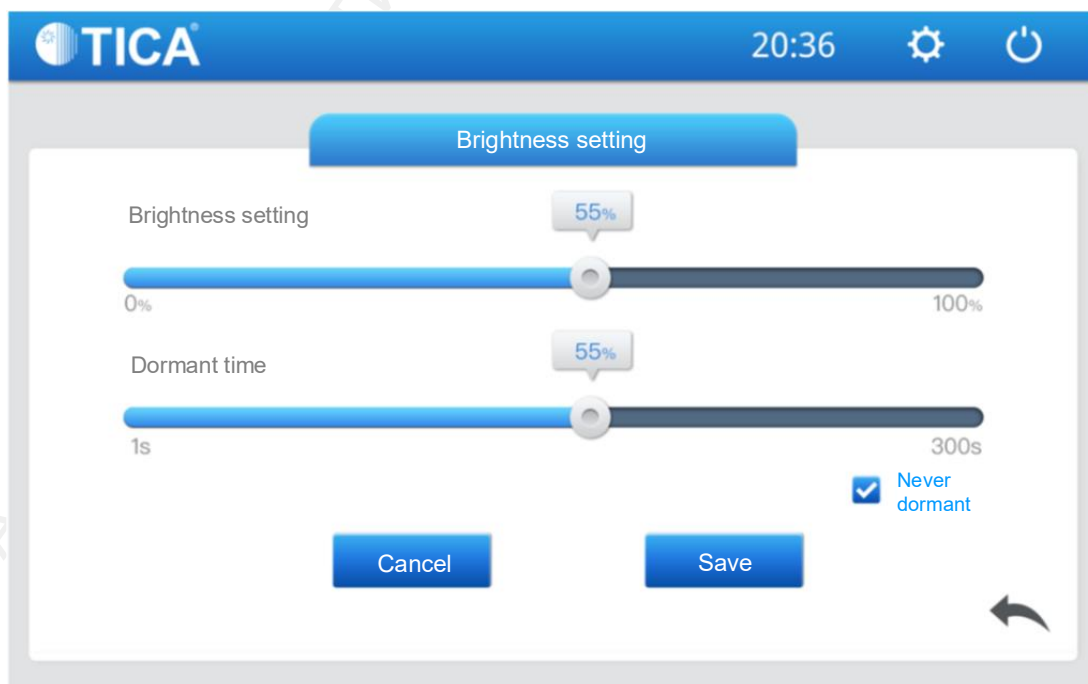

8.3 Service support

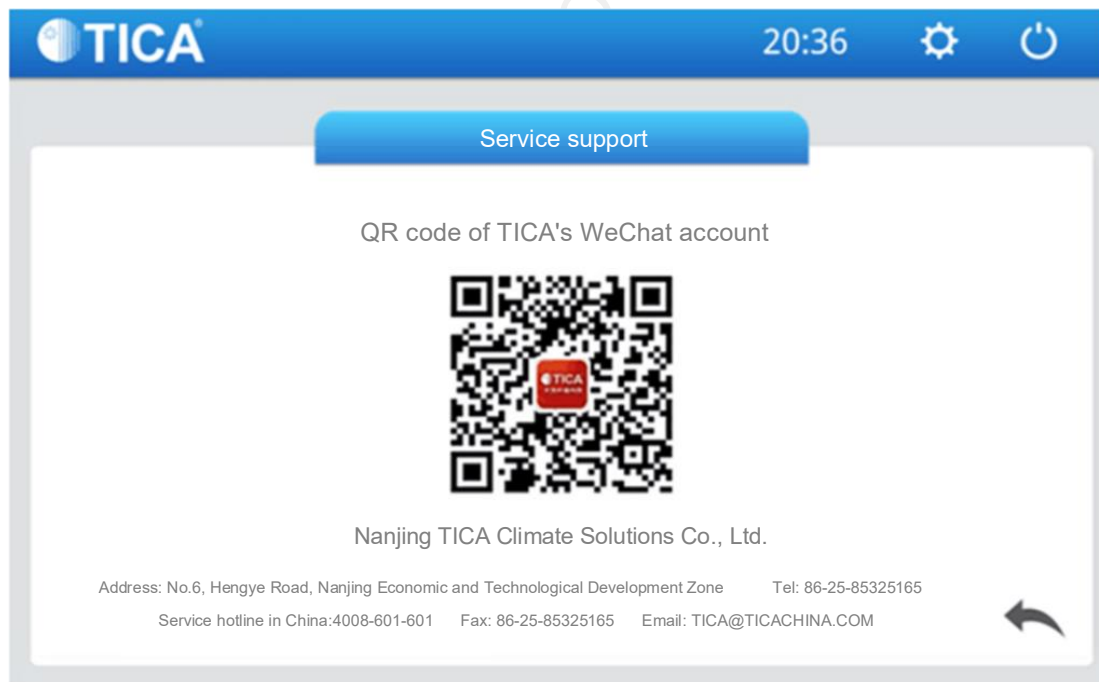

9. Application setting as follows: (Note: the secondary interface is not shown here)

1. Historical graphs: Operating curve of the IDU for temperature/humidity/PM2.5.
2. Wired controller enabled: Enable the wired controller.
3. Group settings: Perform group setting on all IDUs.

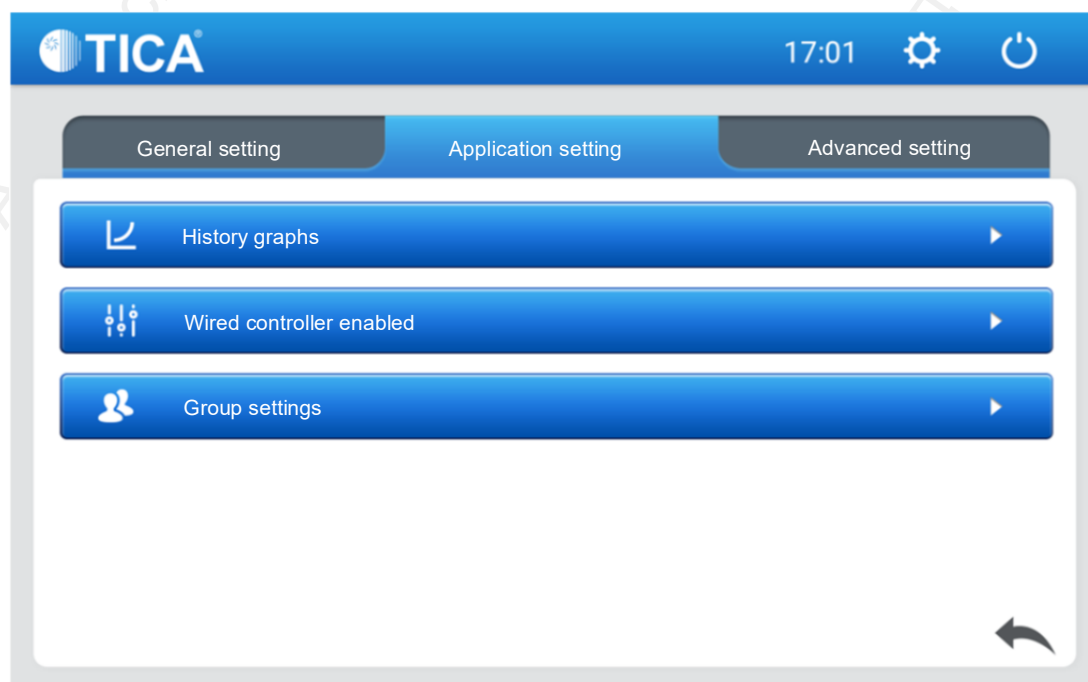

9.1 Historical graphs

Tap **History graphs** and select a time period to display PM2.5, temperature or humidity selected. You can select a curve for any device (The data curve of the previous hour is shown by default. Data for the latest 7 days is available for selection)



9.2 Wired controller enabled

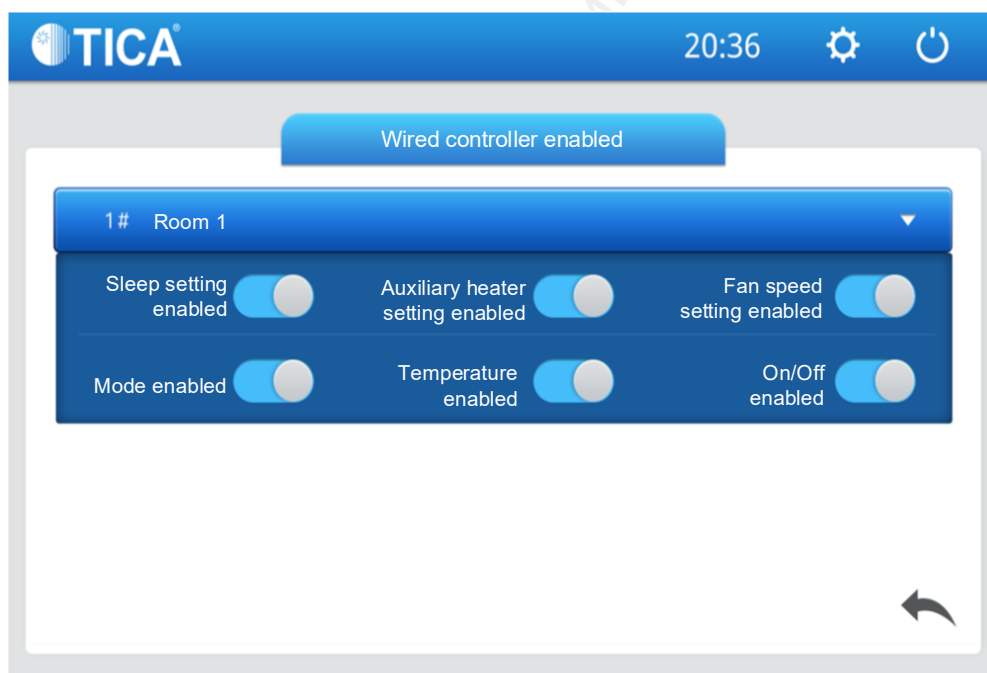

9.3 Group settings: The corresponding IDU is displayed under that group. If no group is selected for the IDU, this IDU can be assigned to a group

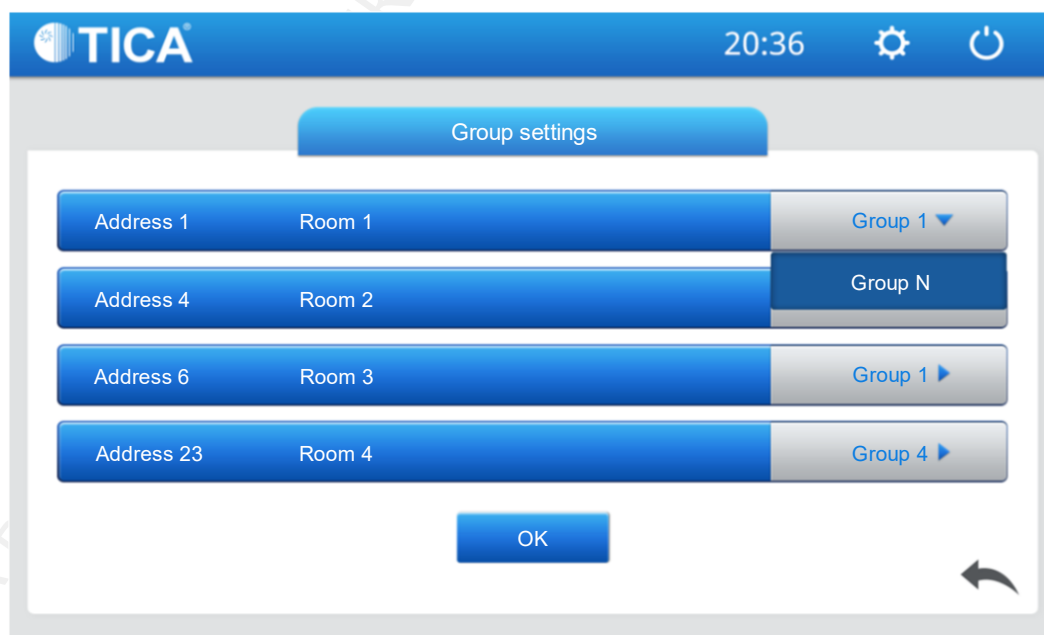

10. Advanced setting: Tap to open the screen requiring you to input administrator password. Type the password 0520 correctly and enter the following screen: (Note: the secondary interface is not shown here)

1. Search for devices: Enter the page inside and tap **Scan to search** to scan all online devices and display addresses and quantities. If the quantity is consistent with the actual quantity installed, after you tap **OK**, the corresponding IDU appears on the homepage. If the quantity does not match the actual quantity, tap **Search again**.
2. IDU status: Running status data.
3. ODU status: Running status data.
4. Fault log: Inspection and export of faults and operation dates of IDU and ODU. The part highlighted in yellow in the agreement.
5. Restore factory settings: Reinitialize the parameters of IDU and ODU.

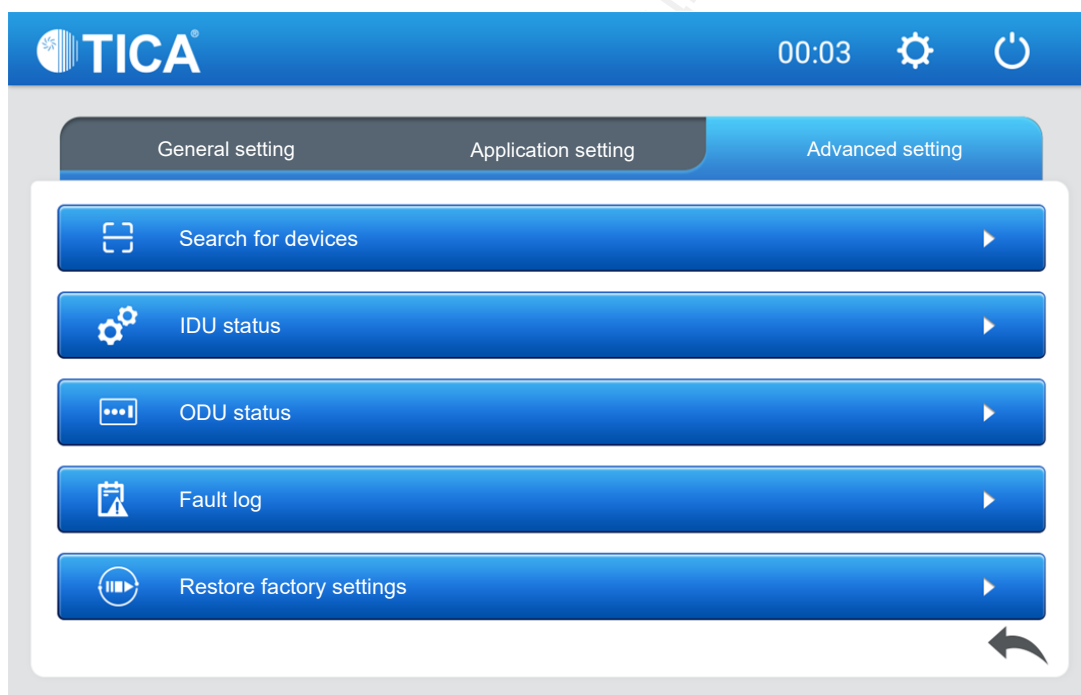
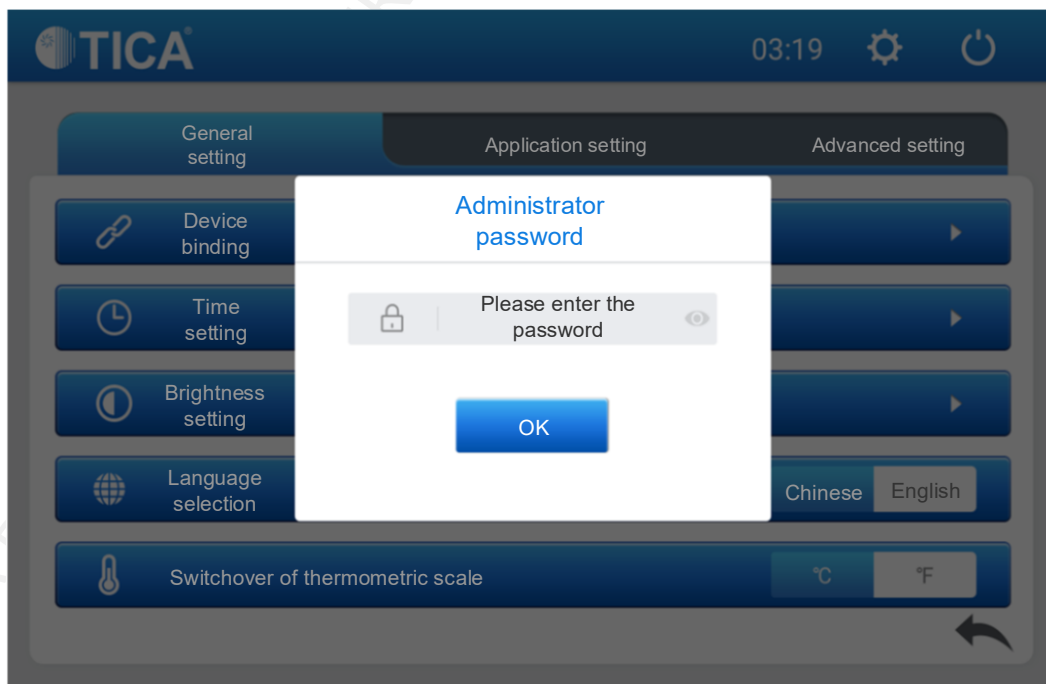

10.1 Search for devices

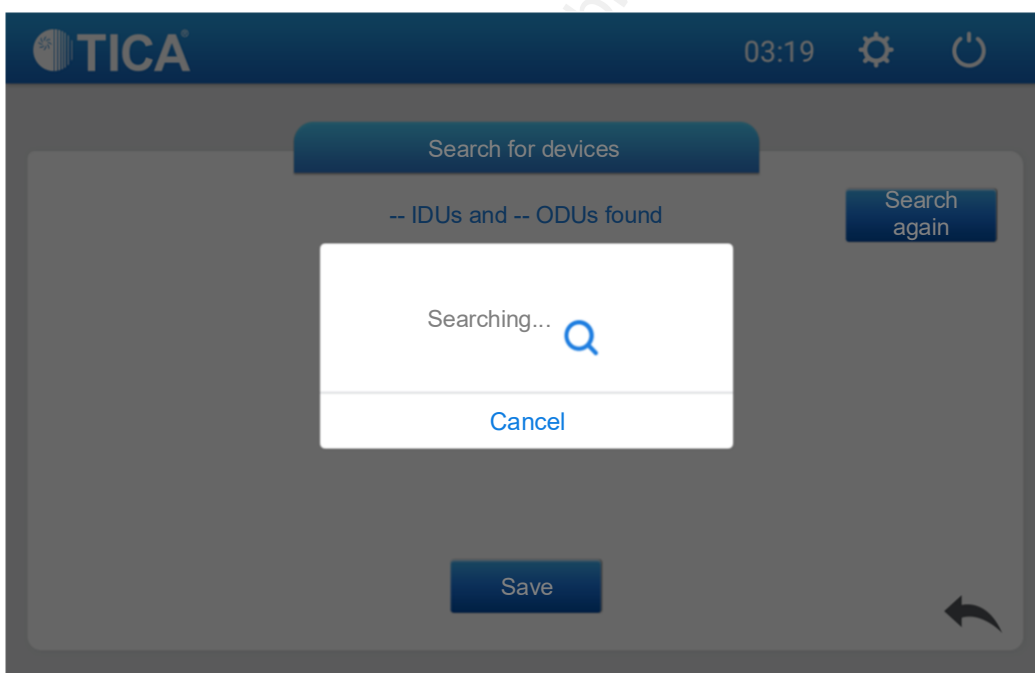
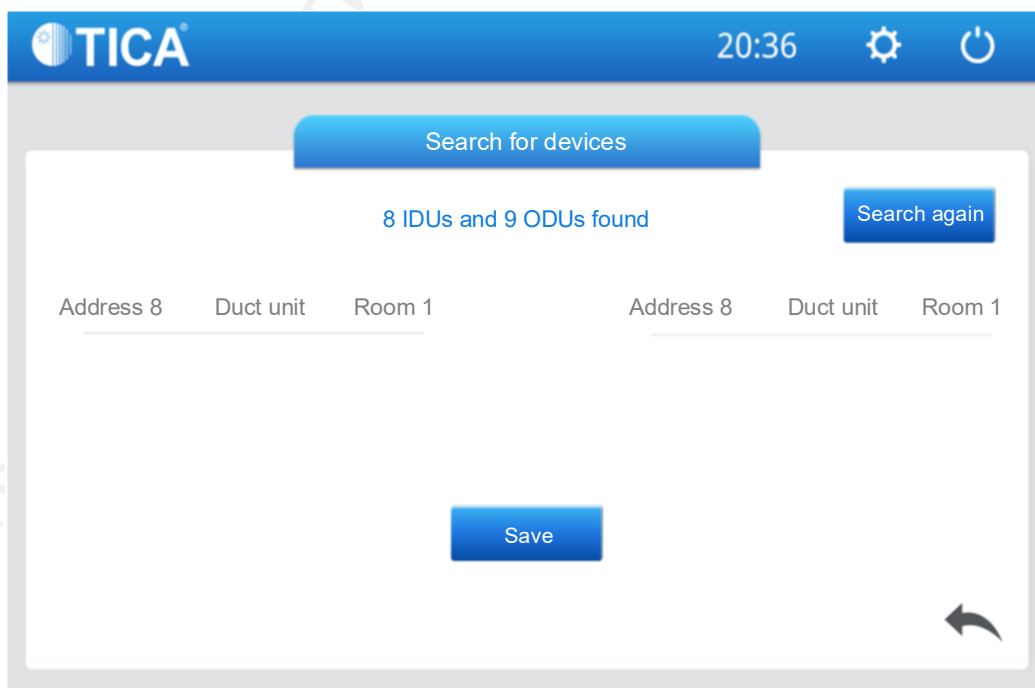

10.2 IDU status:

The current running status data of the IDU under polling and its storage, such as model capability, running status mode, relevant temperature, corresponding quantity of IDUs and other parameters.

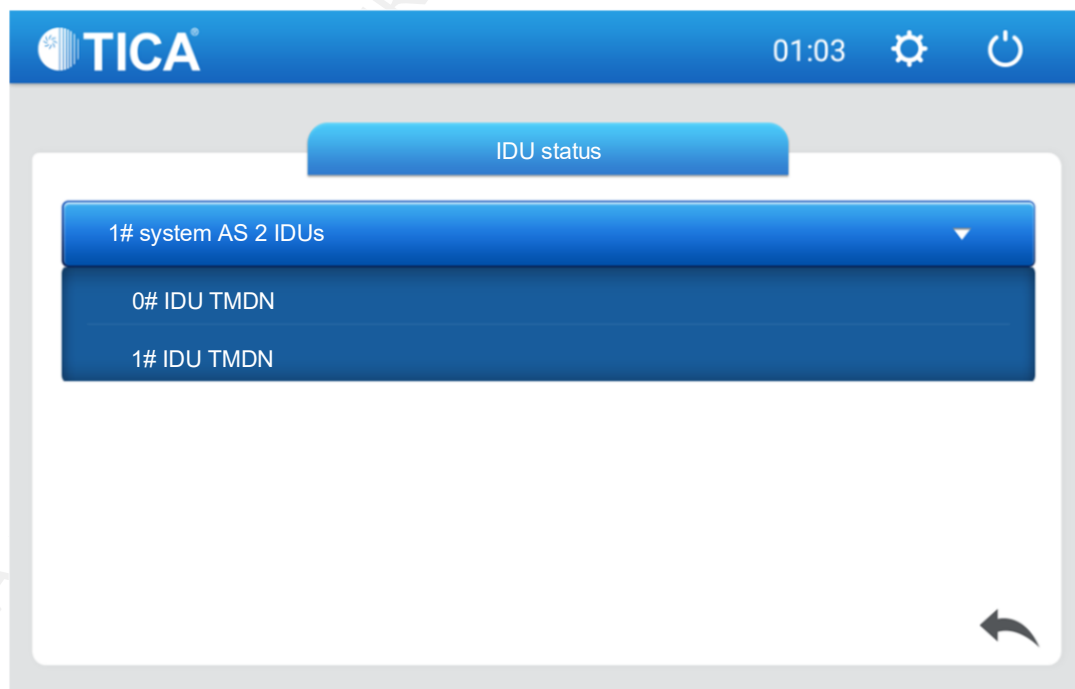

10.3 ODU status

The current running status data of the ODU under polling and its storage, such as model capability, running status mode, relevant temperature, corresponding quantity of IDUs and other parameters.

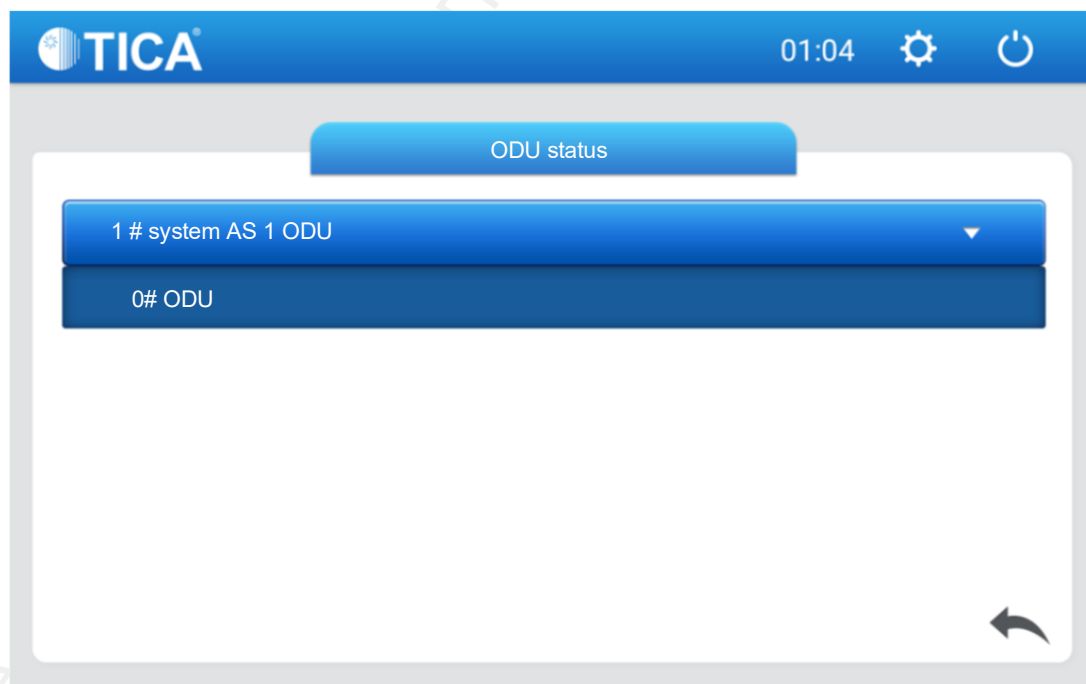

10.4 Fault log

The current real-time faults of IDU and ODU are listed and displayed. Related logs can be selected for export. (Plug in external SD card)

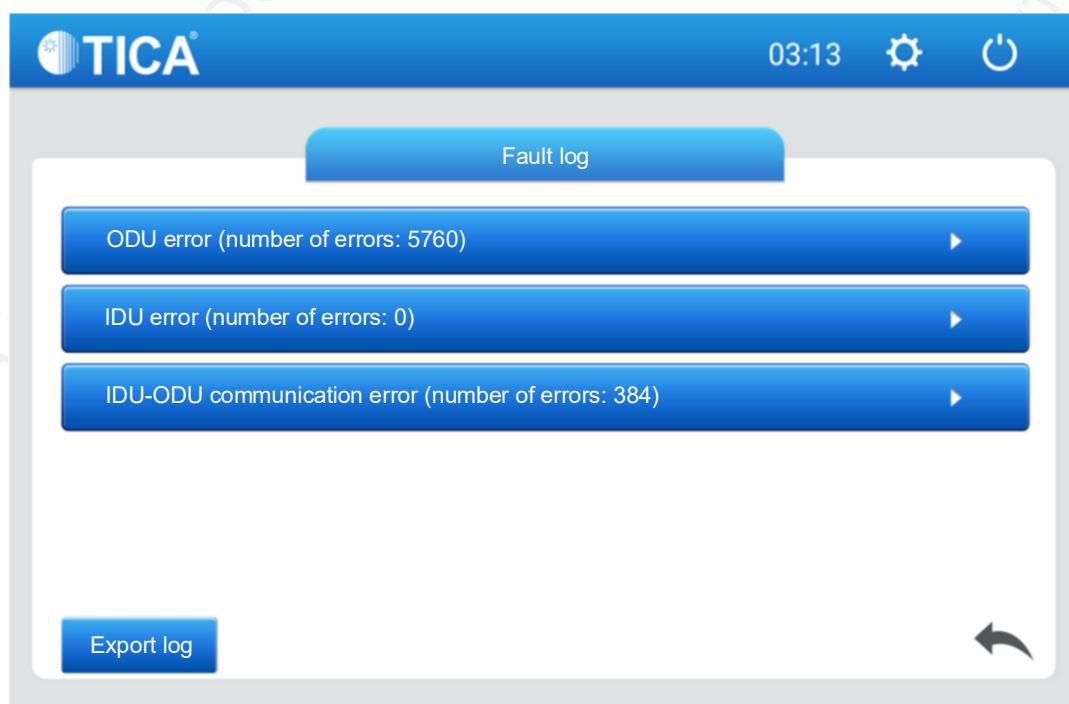

10.5. Restore factory settings: Reinitialize the parameters of IDU and ODU.

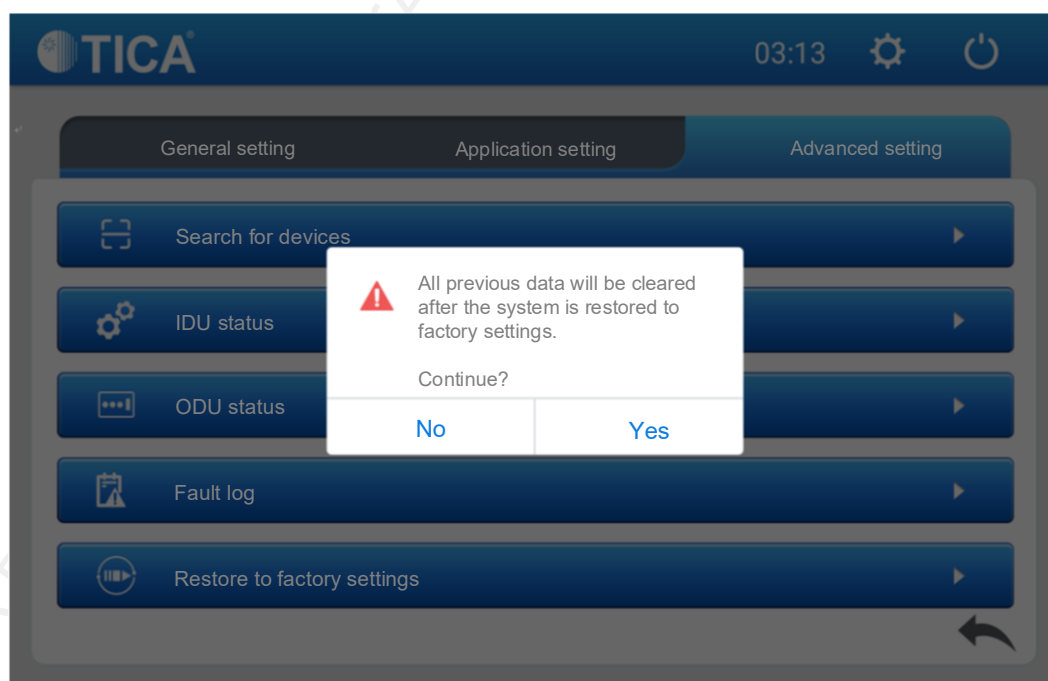

TICA PRO LLC

Tel.: +7 495 822-29-00

E-mail: info@tica.ru

www.tica.ru



Note: Due to constant improvement and innovation of TICA's products, the product models, specifications and parameters contained in this document are subject to change without prior notice.