



TICA PRO LLC
www.tica.pro

TICA CLIMATE
SOLUTIONS
**Light Commercial
Air Conditioner**



LIGHT COMMERCIAL
AIR CONDITIONER



TICA® 天加

Founded in 1991, TICA specializes in clean environment and thermal energy utilization and integrates R&D, manufacturing, sales and service. TICA owns four production sites in Nanjing, Tianjin, Guangzhou, and Chengdu, and a network of over 70 sales and service filiales around the world.

TICA is selected by the Ministry of Industry and Information Technology as a national brand cultivation enterprise and appointed the vice chairman unit of China Refrigeration and Air-Conditioning Industry Association. TICA products can be found from a variety of well-known projects, including Bird's Nest Gymnasium, Water Cube, and Cadillac Arena in Beijing, CNPC, Sinopec, State Grid, Nanjing CEC Panda, Hangzhou Xiaoshan Airport, HNA Group, Shangri-La, Manila Ocean Park, Al Muneera, Shoe Mart in Philippines, and Unilever.

TICA is also an outstanding central air-conditioning supplier of China Metro, and has successfully served more than 40 key subway lines in Beijing, Shanghai, Guangzhou, Shenzhen, Chengdu, Suzhou, Hangzhou and Tianjin. While for microelectronics, hospital operating rooms, biopharmaceutical industry and other professional purification areas, our market share has achieved over 40% in each.

As a national high-tech enterprise, TICA has a nationally recognized enterprise technology center, an enterprise academician workstation, and a postdoctoral research station. TICA product lines cover clean unit, fresh air unit, clean AHU, modular chiller, VRF unit, screw chiller, centrifugal chiller, and include ORC low temperature power generation system. With the excellent performance of the clean air processor, TICA is selected as a single champion cultivation enterprise in the manufacturing industry by the Ministry of Industry and Information Technology.

In terms of core technology, TICA has built an "ISO Level 1" ultra-clean environment integration system. With the technology, TICA won the first prize of China Machinery Industry Science and Technology. Meanwhile, TICA and United Technologies Corporation (UTC) of U.S. established a global strategic joint venture, and TICA's efficient centrifugal chiller, water-cooled screw chiller and air-cooled screw chiller are manufactured by UTC's Carrier Corporation with technical license. TICA acquired the Purecycle series ORC low-temperature power generation system of UTC's Pratt & Whitney, and obtained the Purecycle trademark and more than 100 international patents. In terms of R&D capabilities, TICA has a nationally recognized enterprise technology center, an enterprise academician workstation, and a postdoctoral workstation. Phase I construction investment of the HQ base reached CHY 600 million. An environmental control R&D base is built with more than 30 CNCA CNAS laboratories. TICA's Research Institute built in Osaka, Japan, is responsible for the development of VRF unit, heat pump water heater, cryogenic refrigerator, heat pump chiller, professional ACU, and air purifier.

Adhering to the principle of quality-based development, TICA began to implement the "Ten-Year Quality Enhancement Plan" from 2011 and attracted senior management teams from Japan to control the whole process of R&D, process, manufacturing and quality. The quality of TICA's products gets comprehensive improvement.

TICA imported the Amoeba business model of Japanese Inamori Kazuo and UTC's ACE operation system (to gain competitive advantage), consolidated the foundation and built a competitive system.

TICA aims to build itself into a world-leading system integration supplier and service provider that specializes in clean environment and thermal energy utilization.



Nanjing Headquarter



Tianjin Base



Guangzhou Base



Chengdu Base

Four Production Bases Deliver Outstanding Quality



1 Nanjing Headquarter
 Floor area of 170,000 m²
 Construction area of 90,000 m²

2 Tianjin Base
 Construction area of 30,000 m²

3 Guangzhou Base
 Construction area of 60,000 m²

4 Chengdu Base
 Construction area of 20,000 m²

Purifying Air Conditioner Leader in China Purifying Product Champion Enterprise (Only one in central air-conditioning industry)

- Winner of the 1st Grade Tech-Progress Award CMIF
- One of the first individual product champion enterprises accredited by NMII
- One of the national Top-10 cleaning equipment and material suppliers
- National-recognized enterprise technology center
- High & new tech enterprise
- Enterprise academician workstation
- Vice chairman member of China Refrigeration and Air-conditioning Industry Association
- Postdoctoral Programme
- National Green Industry Building. No.001 in China (first one in China)





Global leading ISO class 1
Ultra-clean integrated
environmental system



- Storage area of largest enthalpy difference laboratory in air-conditioning industry
- Certified by CNAS

R&D facilities

- The largest air flow test platform in the industry (120,000 m³/h)
- Highway transportation simulation test platform
- Noise test room
- Low temperature snowfall simulation lab
- Stress and strain test lab
- Air purification particle analytical lab

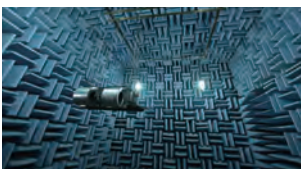

Production facilities

- Largest production building in the central air-conditioner industry
- Central gas/liquid transport zone
- Japan Murata sheet metal fabrication center
- CombiCut plasma cutting
- China's most advanced VRF line based on Japanese technology
- Automated painting line (Wagner, Germany)



CONTENTS

Purified cassette unit	4
Purified duct unit	7
Low static pressure duct unit	7
Medium static pressure duct unit	11
High static pressure duct unit	13
Controller	15
Options	16
Technical specifications	17
Dimensions	20
Wide application	25

Excellent Quality Helps Customers Succeed

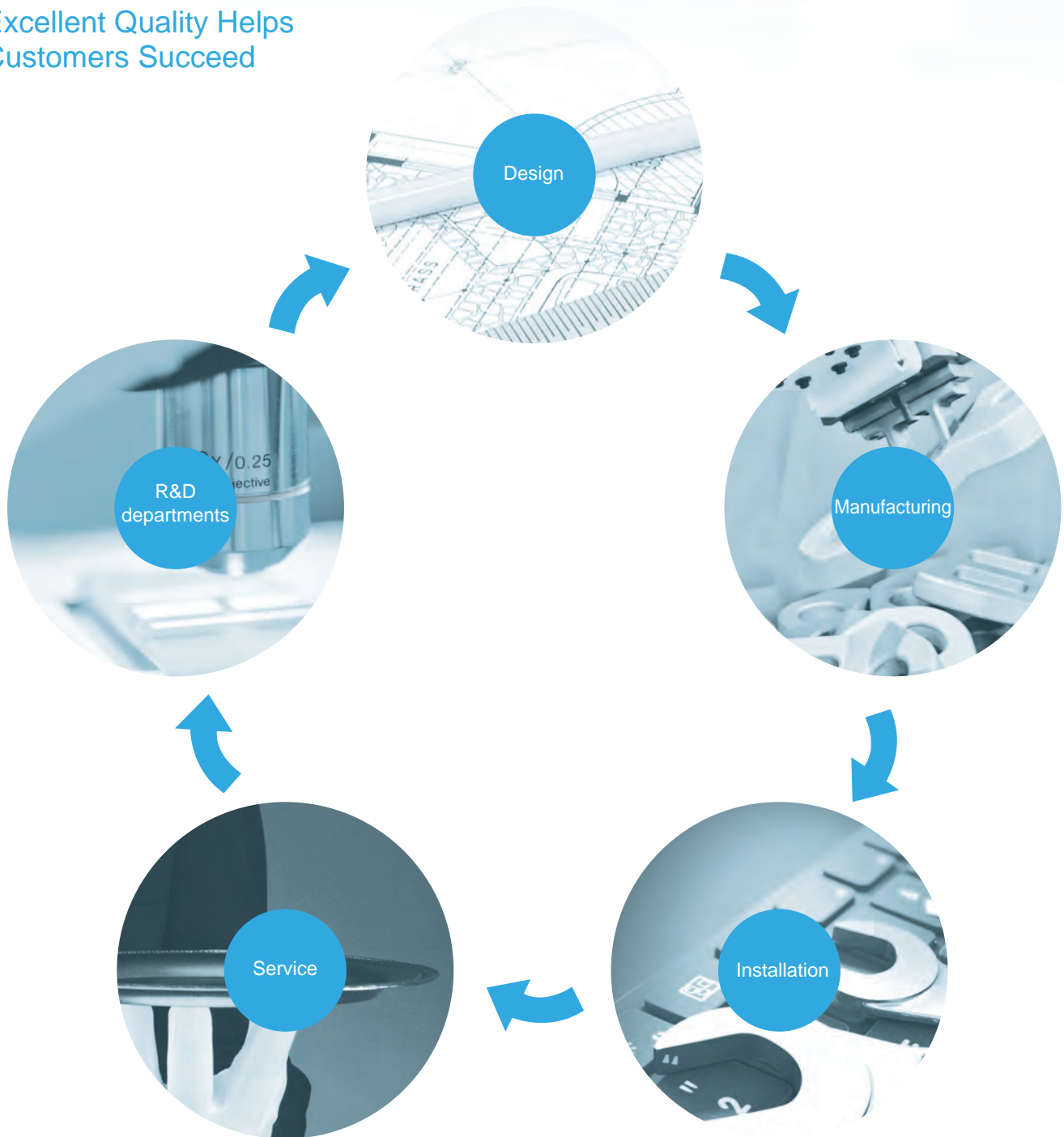

Purified cassette unit



The purified cassette unit provides an elegant panel to improve the interior decor. Moreover, it is featured by multi-directional air flows, 360° air supply and proper air distribution and balanced temperature control to meet your business needs.

Low static pressure duct unit



The low static pressure duct unit is equipped with the high-efficiency V-type heat exchangers with the symmetric design to realize stronger cooling and heating performance with a thinner and lighter body, minimizing the noise and installation dimensions to meet the needs of business users.

Medium static pressure duct unit



Thanks to the global leading compressor, the medium static pressure duct unit reaches the level-1 energy efficiency. The maximum static pressure reaches 100 pa, offering strong power to supply air to rooms of different irregular shapes.

High static pressure duct unit



The high static pressure duct unit can offer a maximum static pressure of 196 pa. With ducts distributed, the unit can be applied to spacious, high ceiling places, such as shopping malls, restaurants, supermarkets and meeting rooms.



The purified cassette unit provides an elegant panel to improve the interior decor. Moreover, it is featured by multi-directional air flows, 360° air supply and proper air distribution and balanced temperature control to meet your business needs.

Energy-efficient Solution

High-quality components enable operation in different working conditions

Global-leading scroll compressor ensures outstanding performance and reliability. The operating temperature range for cooling and heating is 17-43°C and -10-21°C respectively. The whole series provide auxiliary heater which allows quick start and smart operation to serve customers in summer and winter.

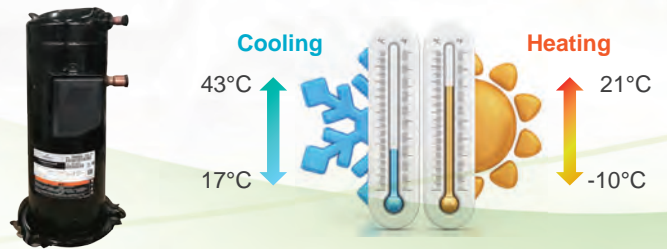

Super-high wide angle of air supply, maximizing comfort for users

The super-high wide-angle airflow maximizes the area of air supply. Moreover, the ultra-high fan speed allows its users to enjoy hot air even in a room with a ceiling height of 3.5 m in winter.

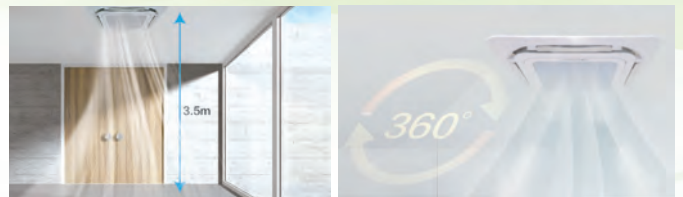

Super-high energy efficiency

The R410A refrigerant is used to prevent environmental pollution. Moreover, R410A is more efficient than the traditional R22. The energy efficiency of the unit can reach Grade 2 of China Energy Efficiency Grade.



Minimalist and Luxury

Ultra-thin design

The unit, only 230 mm at its thinnest, can be installed in a narrow ceiling space to meet the needs of modern interior decor.



Smooth water drainage

Condensate pump is equipped to realize reliable water drainage at the height of 1,200mm, simplifying the drain pipe arrangement.

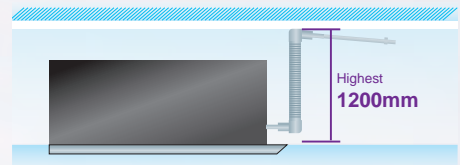

Fast installation

The outdoor unit is equipped with a 270° connection pipe. The indoor and outdoor units communicate with each other via the RS485 interface, thus further simplifying installation.



Enjoy the Clean and Quiet Life

Enjoy clean air in life

PM2.5 and formaldehyde filter makes the panel thinner, lighter and more attractive.



Streamlined panel

The large air inlet grille adopts a streamlined design to optimize the airflow organization and reduce resistance and noise.



Silencing components

An efficient silencer is added inside the pipeline to effectively reduce the impact of the compressor's high temperature and high pressure gas on the pipeline, stabilize the gaseous refrigerant flow and reduce noise.



Low-noise blades

The ODU uses $\phi 500\text{mm}$ super-large blades that feature aerodynamic design to avoid generation of vortices and reduce wind resistance. The blades produce high air flow and low noise.

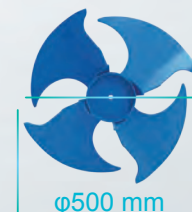

Intelligent Control

Filter cleaning reminder

The indoor unit has a filter cleaning reminder to ensure the filtering efficiency and maintain indoor air quality.



Power-on/off using hotel room card

The function of power-on/off by using the hotel room card is provided. When the room card is inserted, the indoor unit is powered on. When the card is removed, the indoor unit is powered off.



Power failure memory

The unit has the power-off memory function. After the power is restored, the unit automatically restores to the setting before power-off, thus saving the trouble of power-on for users. The function can be set to the manual mode.

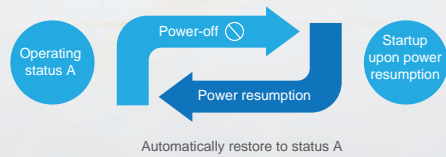

Smart defrosting

The outdoor unit provides the function of smart defrosting, which is enabled only when necessary, thus minimizing indoor temperature fluctuations caused by frequent defrosting.

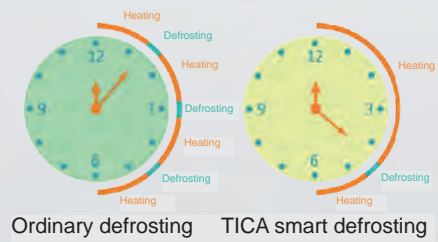

Control system

The control system implements both centralized control and group control over up to 16 units. It has a 7-day timer. Supported by the BACANET protocol, it can be directly connected to a building automation system.



Control panel

The new wired controller panel provides touch buttons and realizes multiple functions such as the display of PM2.5, temperature and humidity and can receive simple remote controller signals.



TICA Light Commercial Air Conditioner

Low Static Pressure Duct Unit

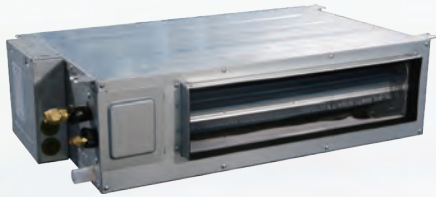

The low static pressure duct unit is equipped with the high-efficiency V-type heat exchangers with the symmetric design to realize stronger cooling and heating performance with a thinner and lighter body, minimizing the noise and installation dimensions to meet the needs of business users.

High efficiency product

R410A environment-friendly refrigerant with level-1 energy efficiency

R410a is environment-friendly refrigerant, with no damage to the ozone layer and high heat exchange performance, thus enhancing the unit performance and reducing the energy consumption.



3-row $\phi 7$ mm copper tube V-type heat exchanger

The original 3-row $\phi 7$ mm copper tube V-type heat exchanger features the large heat exchange area, high heat exchange efficiency, symmetric design of heat exchanger and uniform distribution of the wind field. The design of special auxiliary flow path maximizes the heat exchanger performance.



Adaptive various working conditions

The cooling temperature range is $17^{\circ}\text{C} \sim 43^{\circ}\text{C}$ and heating range $-10^{\circ}\text{C} \sim 21^{\circ}\text{C}$, which meets the requirements of indoor heating and cooling.

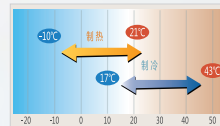

Super-large blades

The ODU uses $\phi 500\text{mm}$ super-large blades that feature aerodynamic design to avoid generation of vortices and reduce wind resistance. The blades produce high air flow and low noise.



Enjoy the Comfort

Round air flow

The reasonably designed supply air outlet and return air inlet form a stereoscopic four-dimensional surrounding air flow to provide a gentle breeze. The high air outlet design of heating and the maximum 30 Pa static pressure ensure omnidirectional coverage of the air flow and avoid the blind angle of air supply.



Smart temperature regulation

The indoor unit can adjust the room temperature according to the temperature detected at the return air inlet of unit and controller, meeting the needs of different customers.



Intelligent defrosting

Intelligent defrosting supports precise determination of ODU defrosting status and optimizes defrosting plans accordingly to create a better indoor environment.

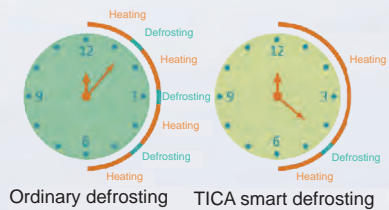

Enjoy fresh air in life

A fresh air inlet is reserved for the unit to introduce a maximum of 15% fresh air, making sure that the user can enjoy fresh oxygen-enriched air at home. One IDU can implement multiple functions including fresh air, temperature adjustment, humidity adjustment and purification.



Enjoy the quiet life

CFD optimized duct design, making air supply more gentle;
Multi-wind wheel design, stabilizing the air flow;
With the external electric control box, the return air is more balanced;
The guide ring imitates the design of airfoils to improve the balance.

20dB(A) Leaves fall to the ground	23dB(A) IDU silent operation mode	30dB(A) Library	40dB(A) Language lab	50dB(A) Office

Effective sound insulation

Three-layer silencer is used in the compressor to absorb, insulate and eliminate noise. LC porous sound-absorbing cotton is used. It features resistance to distortion and aging for insulation and sound absorption.

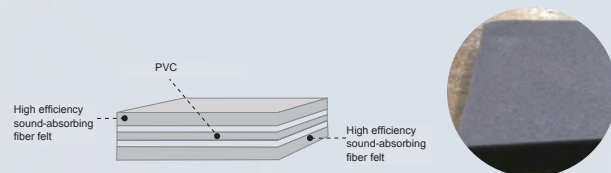

Intelligent Control

Power-on/off using room card

Designed for places such as hotels to work with the specially customized hotel room card; the controller can control the IDU freely when the room card is inserted; the IDU is powered off automatically and in the standby status when the room card is removed.

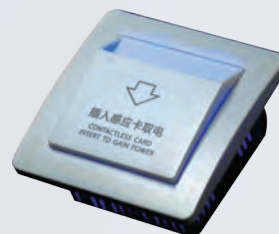

Fire control linkage

Designed for the public places, reporting the fire alarm linkage signal through the fire alarm control; able to stop the entire unit immediately in an emergency and reduce the risk loss.



Comprehensive control

The unit can be controlled via various means such as wired controller and remote controller. The control system implements both centralized control and group control over up to 16 units. It has a 7-day timer.



Control panel

Touch-type wired control panel provides touch buttons and a large display with a black background and white back light. It can display clearly at night and realize infrared remote control through the remote controller.



Power failure memory

The unit can remember the working status before the air conditioner is powered off and start the operation according to the remembered status after power resumption. The function can be set to the manual mode.

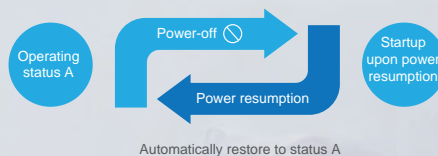

Convenient Installation

Ultra-thin unit body can easily fit into the interior decor

TICA low static pressure duct units have a compact structure and elegant appearance. The body is only 200 mm thick, not only increasing the utilization rate of house space and ceiling height, but also improving comfort. The small depth of 450 mm applies to the bedroom of smaller depth.

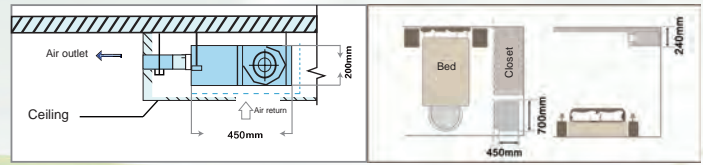

Left/right drainage, and less pipe bends

The user can freely choose left/right drainage according to site conditions. The drainage pipeline system is simple with less bends for smooth drainage.

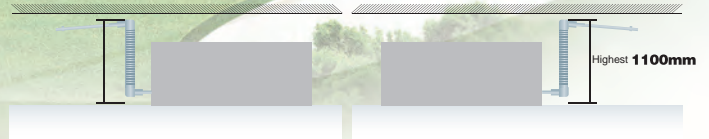

Free air return, adjustable on the field

The unique "high strength and low noise" design is adopted for the fan mounting plate, and the two flexible engineering installation methods of bottom return air and back return air can be implemented to meet different ceiling conditions and user requirements.

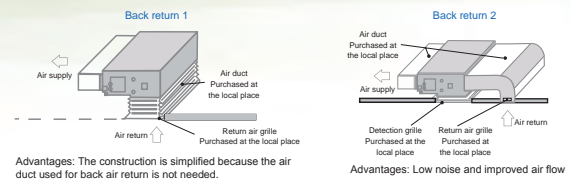

Multiple static pressures adapt to different installation conditions

The default static pressure of the unit is 10 Pa, and the air outlet panel or short-distance duct can be directly connected. The 30 Pa static pressure can be adjusted on the field, and the return air purifier or longer-distance duct can be selected. Various static pressures can meet the requirements of different sites.

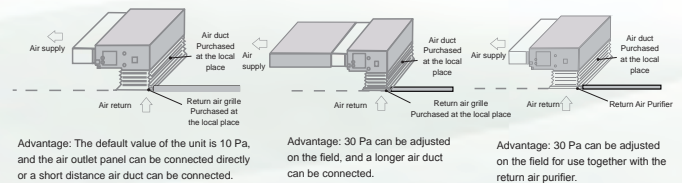

Condensate water pump improves the drainage performance

The 1,100 mm condensate water pump can be selected to simplify the arrangement of pipes.

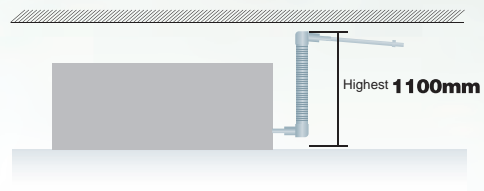



Thanks to the global leading compressor, the medium static pressure duct unit reaches the level-1 energy efficiency. The maximum static pressure reaches 100 pa, offering strong power to supply air. It can be widely used in shopping malls, restaurants, supermarkets and meeting rooms.

Energy-efficient solution

High-efficiency core

High-quality low-pressure cavity high-efficiency scroll compressor is used to provide strong power and resistance to liquid impact with high operating efficiency and long service life.



Grade-1 energy efficiency

The unit uses environment-friendly R410A refrigerant, which not only minimizes damage to the ozone layer, but also increases the heat exchange efficiency, thus improving the unit performance and lowering energy consumption to Grade 1.



Static pressure adjustable: 30/50/70/100Pa, adaptive to various conditions

Higher static pressure realizes the separation of the indoor unit and the air outlet and realizes multi-point long-distance air supply through the duct; It can supply air evenly in L-type, T-type, U-type and other rooms of irregular shapes.

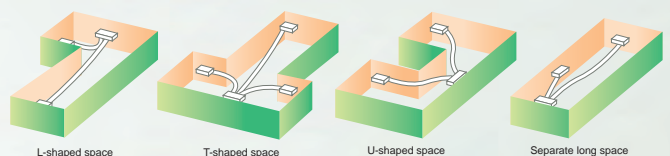

Elegant Design

Flexible air outlet

Depending on the decoration style and the owner's requirements, the air outlet can be freely adjusted from round, square diffuser to slotted air outlet which is both attractive and comfortable.

Low noise

The CFD simulated duct uses foam and muffler cotton to reduce noise to just 39 db at the lowest.

Flexible drainage

Use a suitable built-in pump to increase drainage capacity without affecting the ceiling height.

Invisible installation and elegant appearance

The indoor unit and duct are hidden in the ceiling and can fit into the interior decoration perfectly.

Intelligent Control

PTC auxiliary heater

The optional PTC auxiliary heater can ensure effective heating in winter depending on the outdoor operation conditions.

Power-on/off by plugging a room card

Thanks to the function of power-on/off using hotel room card, users can insert specially designed hotel room cards to control the indoor unit automatically and unplug it to power off the unit.

Power failure memory

The unit can remember the status before the air conditioner is powered off and start the operation according to the remembered status after power resumption.

Comprehensive control

The control system implements both centralized control and group control over up to 16 units. It has a 7-day timer.

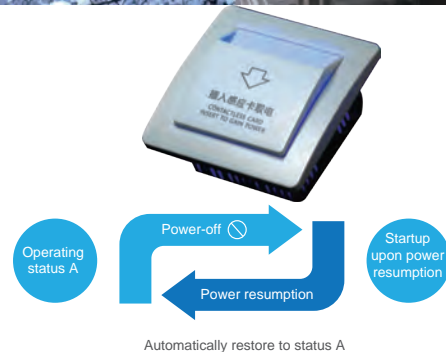
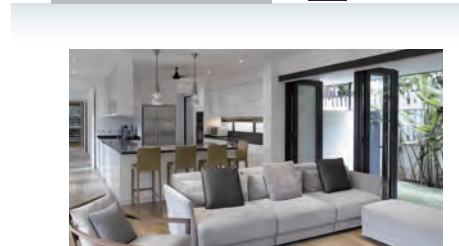
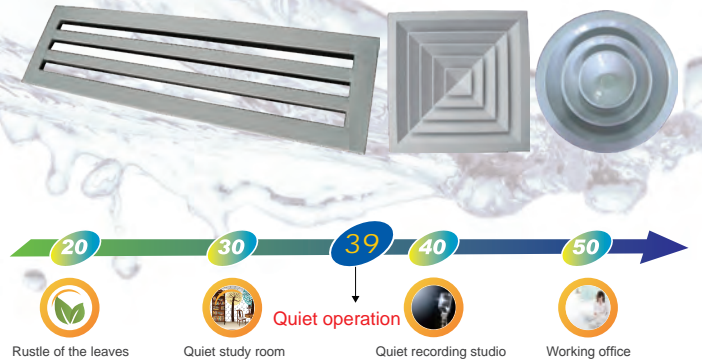



The high static pressure duct unit can offer a maximum static pressure of 196 pa. With ducts distributed, the unit can be widely used in shopping malls, restaurants, supermarkets and meeting rooms.

Energy-efficient solution

Powerful core

Use low-pressure-chamber and high-scroll compressor of an internationally renowned brand that features robust power.

Super-high static pressure

The maximum static pressure is 196 Pa in air outlet mode.

Super-high energy efficiency

The unit uses environment-friendly R410A refrigerant, which not only minimizes damage to the ozone layer, but also increases the heat exchange efficiency, thus improving the unit performance and lowering energy consumption to Grade 2.

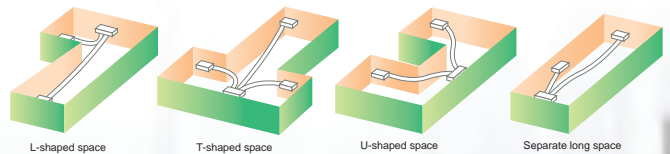

Elegant Design

Invisible installation

The indoor unit and duct are hidden in the ceiling and can fit into the interior decoration perfectly.



Flexible drainage

A suitable external pump can be used to increase drainage capacity without affecting the ceiling height.

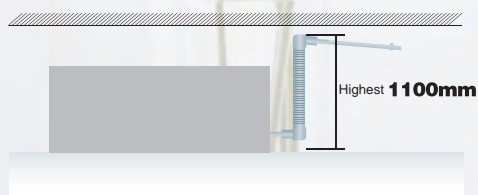

Intelligent Control

PTC auxiliary heater

The optional PTC auxiliary heater can ensure effective heating in winter depending on the outdoor operation conditions.



Power-on/off by plugging a room card

Thanks to the function of power-on/off using hotel room card, users can insert specially designed hotel room cards to control the indoor unit automatically and unplug it to power off the unit.

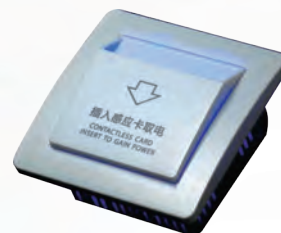

Power failure memory

The unit can remember the status before the air conditioner is powered off and start the operation according to the remembered status after power resumption.

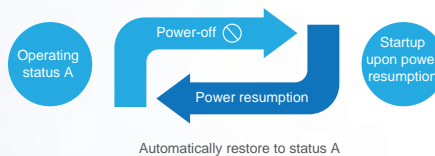



86*86 touch display
 Power on/off
 Temperature/Air Direction
 Cool/Dry/Fan/Heat/Auto
 Sleep/Timer
 It can receive remote control signals
 It can display PM2.5
 Digital display of error codes

Wired controller



Centralized controller

Cloud smart centralized control system
 8" colored LCD
 Resolution 1280*800
 Mode, fan speed, and temperature control
 Temperature, humidity, and PM2.5 are displayed.
 A maximum of 64 sets of units can be controlled in a centralized manner.
 Control can be implemented based on a single unit/group or in a centralized manner.
 Smart scene setting makes device time management possible.
 Support WiFi connection to implement remote control.
 Support fault alarming and remote analysis of faults.



Remote Controller

Power on/off
 Temperature/Air Direction
 Cool/Dry/Fan/Heat/Auto
 Sleep/Timer
 It can realize simple control on TMC370A



Remote controller receiver

Attractive and elegant appearance
 Attractive and elegant
 The signal receiving angle reaches 120°. It can display timer/energy saving/defrosting/filter replacement and other functions.
 It can receive remote control signals

Operating Principles

The pre-filter layer removes hair, dust, and large particles from the air; the professional PM2.5 filter layer adopts the unique electrostatic technology to remove PM2.5 from the air through physical adsorption measures, without causing ozone hazard; the capture agent on the formaldehyde filter surface shows a formaldehyde removal capacity more powerful than that of the traditional activated carbon net, and converts the formaldehyde in air into a kind of safe and harmless substance through chemical reaction, instead of releasing it into the room with air and without leading to secondary pollution because of excessive adsorption and heating.



上海市环境保护产品质量监督检验站
检测报告

序号	检测项目	单位	检测结果	标准要求
1	PM2.5 滤除率	%	96.00	≥ 90
2	PM10 滤除率	%	99.00	≥ 90
3	PM10 阻力	Pa	8.00	≤ 10
4	PM10 流量	m³/min	1.11	≥ 0.8
5	PM10 阻力	Pa	1.33	≤ 2.0
6	PM10 流量	m³/min	1.00	≥ 0.8
7	PM10 阻力	Pa	1.00	≤ 1.5
8	PM10 流量	m³/min	1.00	≥ 0.8

PM2.5 filtration efficiency reaches **96%** (in a cycle of 120 min)

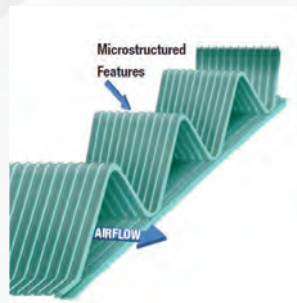

PM2.5 filter

- Low resistance: 8 Pa & 1 m/s, open channel;
- High efficiency: The unique electrostatic technology enables the static electricity on the filter to last for a period as long as 10 years.
- Self-supporting structure, no frame is needed
- 100% synthetic fiber, resistant to moisture and general chemicals;
- Environmentally friendly and fungus resistant;

The efficient formaldehyde filter layer achieves the effective aldehyde substance filtration efficiency of **90%** (In a cycle of 60 min)

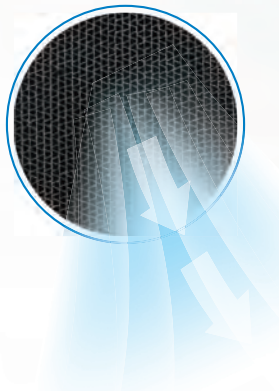

Special glass fiber paper is processed to produce corrugated honeycomb substrate, and the filter layer is made through treatment of trapping agents adsorbing aldehydes. The broad surface of porous carrier is uniformly laid with trapping agents to allow quick reaction with aldehyde group. It is featured by strong adsorption capacity. The aldehyde substances are removed via treatment. No secondary release is caused due to excessive adsorption and heating.

上海市环境保护产品质量监督检验站
检测报告

序号	检测项目	单位	检测结果	标准要求
1	甲醛滤除率	%	90.00	≥ 90
2	PM2.5 滤除率	%	96.00	≥ 90
3	PM10 滤除率	%	99.00	≥ 90
4	PM10 阻力	Pa	8.00	≤ 10
5	PM10 流量	m³/min	1.11	≥ 0.8
6	PM10 阻力	Pa	1.33	≤ 2.0
7	PM10 流量	m³/min	1.00	≥ 0.8
8	PM10 阻力	Pa	1.00	≤ 1.5
9	PM10 流量	m³/min	1.00	≥ 0.8

Specifications

Model	TRP070CPF	TRP090CPF	TRP110CPF
Material	Aluminum alloy		
Color	White		
Rated air flow (m ³ /h)	560	750	1000
Air flow range (m ³ /h)	310-700	700-900	900-1100
Windward fan speed range (m/s)	0.6-1.36	1.02-1.31	1.05-1.28
Resistance range (Pa)	7-22.5	14.6-20.4	15.3-21.1
External dimensions (Length x Width x Height)/mm	1006x306x59	1226x306x59	1446x306x59
Area of windward side (L x W)/mm	672x214	892x214	1112x214
Area of installation (L x W)/mm	980x270	1200x270	1420x270
PM2.5 cycle (2h)	≥96%	≥96%	≥96%
Formaldehyde cycle (1h)	≥90%	≥90%	≥90%
Weight (kg)	3.1	3.7	4.4

Dimensions

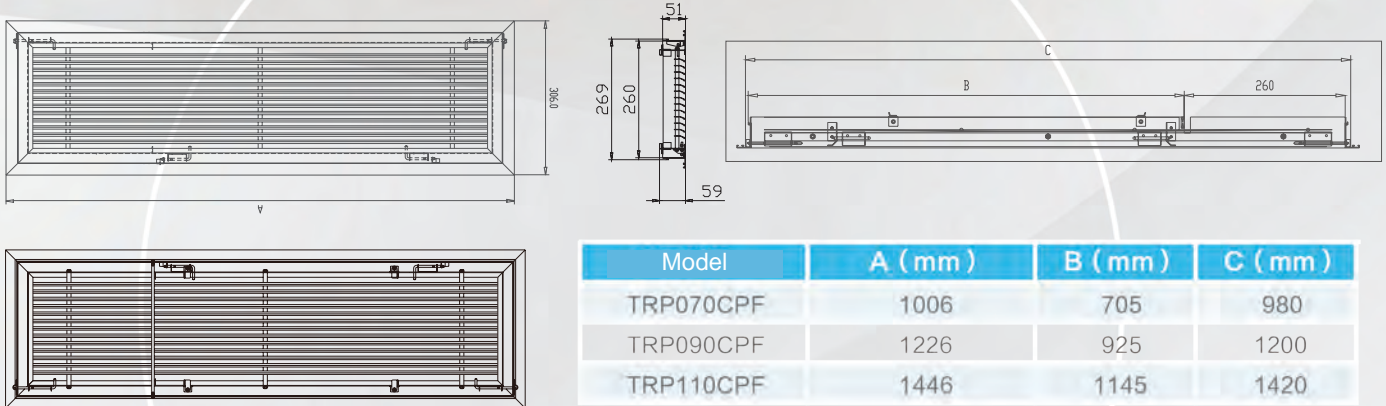

Note: Based on the data in the table, the opening length of the ceiling is C+5mm and width is 275mm.

Precautions for installation and use

Before installation, drill holes on the beam. For details about the hole position, see the installation size diagram.

Canvas should be arranged surrounding the unit evenly and not folded or damaged to avoid air leakage.

It is recommended that the green layer of the composite filter be cleaned on a quarterly basis and replaced on a yearly basis.

It is recommended that the nylon filter be cleaned on a quarterly basis.

The temperature and humidity at the grille inlet must be within the permissible range.

Model	TRP070CPF	TRP090CPF	TRP110CPF
Nylon	914 × 214 × 5mm	1134 × 214 × 5mm	1354 × 214 × 5mm
Composite filter	672 × 214 × 15mm	892 × 214 × 15mm	1112 × 214 × 15mm

Temperature: 0°C-40°C Humidity: 30%-85%

Otherwise, the filter gets deformed easily, which affects efficiency and service life of the filter.

Purified cassette unit



Model	Entire unit	TSA/K20KR(D)Q	TSA/K30KR(D)QE2	TSA/K50KR(D)QE2	TSA/K50KR(D)QE3
	ODU	TSA20KRQ	TSA30KR	TSA50KR	TSA50KRT
	IDU	TSK20KR(D)Q	TSK30KR(D)QE2	TSK50KR(D)QE2	TSK50KR(D)QE3
Cooling capacity	W	5200	7200	12000	12000
Cooling power	W	1600	2380	3970	4100
Heating capacity	W	5800	8000	14000	14000
Heating power	W	1550	2300	4300	4300
Power supply		220V - 50Hz		380V 3N to 50Hz	
Type of auxiliary heater		PTC			
E heating capacity	W	1500	2100	2700	2700
Air flow	m ³ /h	960/780/660	1020/900/690	1800/1500/1200	1800/1500/1200
Noise of IDU	dB (A)	36/33/31	39/36/33	44/40/35	44/40/35
Noise of ODU	dB (A)	55	57	58	58
Dimensions of IDU-ODU connecting pipe	mm	12.7/6.35		15.88/9.52	
Max. pipe length	m	20	20	30	30
Max. level difference of pipe	m	10	10	10	10
IDU dimensions	mm	840×840×230		840×840×300	
ODU dimensions	mm	865×310×700		980×390×1260	
Net weight of IDU	kg	24.5		29.5	
Net weight of ODU	kg	51	55	100	100
Dimensions of condensate pipe	mm	DN25	DN25	DN25	DN25

Low static pressure duct unit



Model	Entire unit	TSA/R10KR(D)C	TSA/R15KR(D)C	TSA/R20KR(D)C	TSA/R25KR(D)C	TSA/R30KR(D)CE1
	ODU	TSA10KR	TSA15KR	TSA20KR	TSA25KR	TSA30KR
	IDU	TSR10KR(D)C	TSR15KR(D)C	TSR20KR(D)C	TSR25KR(D)C	TSR30KR(D)CE1
Cooling capacity	w	2600	3500	5000	6500	7200
Cooling power	w	870	1220	1800	2100	2380
Heating capacity	w	2900	3800	5700	7200	8000
Heating power	w	860	1220	1800	2200	2200
ESP	Pa	10-30				
Power supply		220 V - 50 Hz				
Air flow (H/M/L)	m ³ /h	500/370/310	560/432/360	750/581/482	920/706/582	1000/800/680
E heating capacity	w	950	950	1500	1800	1800
Type of auxiliary heater		Ceramic PTC				
IDU sound level	dB (A)	33/28/23	33/28/24	35/30/28	36/32/28	37/32/29
ODU sound level	dB (A)	50	52	55	56	57
Max. pipe length	m	10	10	20	20	20
Max. level difference of pipe	m	5	5	10	10	10
IDU dimensions	mm	700×450×200		920×450×200	1140×450×200	
ODU dimensions	mm	780×260×540			865×310×700	
Panel	mm	/				
Dimensions of IDU-ODU connecting pipe	mm	φ9.52/φ6.35	φ12.7/φ6.35	φ12.7/φ6.35	φ12.7/φ6.35	φ15.88/φ9.52
Dimensions of condensate pipe	mm	DN25	DN25	DN25	DN25	DN25

Medium static pressure duct unit

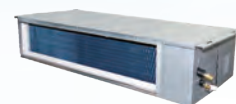

Model	Entire unit	TSA/R50KR(D)BE1	TSA/R50KR(D)BE2	TSA/R60KR(D)BE2
	ODU	TSA50KR	TSA50KRT	TSA60KRT
	IDU	TSR50KR(D)BE1	TSR50KR(D)BE2	TSR60KR(D)BE2
Cooling capacity	w	12300	12300	14000
Cooling power	w	4150	4350	4900
Heating capacity	w	14000	14000	16000
Heating power	w	4250	4450	4850
ESP	Pa	50 (30 to 100)	50 (30 to 100)	50 (30 to 100)
Power supply		380V 3N to 50Hz		
Air flow	m ³ /h	2100 (high wind speed 50 Pa)	2100 (high wind speed 50 Pa)	2400 (high wind speed 50 Pa)
E heating capacity	w	3600	3600	3600
Type of auxiliary heater		Ceramic PTC		
Dimensions of condensate pipe	mm	DN25	DN25	DN25
Max. pipe length	m	30	30	30
Max. level difference of pipe	m	10	10	10
ODU sound level	dB (A)	58	58	58
IDU sound level	dB (A)	39~45	39~45	39~47
ODU dimensions	mm	980x390x1260	980x390x1260	980x390x1260
IDU dimensions	mm	1350x557x292	1350x557x292	1350x557x292
Net weight of ODU	kg	100	100	108
Net weight of IDU	kg	50	50	50
Dimensions of IDU-ODU connecting pipe	mm	9.52/15.88	9.52/15.88	9.52/15.88

High static pressure duct unit



Model	Entire unit	TSA/R50KR(D)HE2	TSA/R60KR(D)HE2
	ODU	TSA50KR	TSA60KRT
	IDU	TSR50KR(D)HE2	TSR60KR(D)HE2
Cooling capacity	w	12300	14000
Cooling power	w	4300	5000
Heating capacity	w	14000	16000
Heating power	w	4250	4850
ESP	Pa	150 (196)	150 (196)
Power supply		380V 3N to 50Hz	
Air flow	m ³ /h	2200 (high wind speed 150 Pa)	2500 (high wind speed 150 Pa)
E heating capacity	w	3000	3000
Type of auxiliary heater		Ceramic PTC	
Dimensions of condensate pipe	mm	DN25	DN25
Max. pipe length	m	30	30
Max. level difference of pipe	m	10	10
ODU sound level	dB (A)	58	58
IDU sound level	dB (A)	46~51	46~51
ODU dimensions	mm	980x390x1260	980x390x1260
IDU dimensions	mm	1200x750x390	1200x750x390
Net weight of ODU	kg	100	108
Net weight of IDU	kg	62	62
Dimensions of IDU-ODU connecting pipe	mm	9.52/15.88	9.52/15.88

Note: 1. The cooling capacity of the unit is obtained from the standard test under indoor dry/wet ball temperature of 27°C/19°C and outdoor dry/wet ball temperature of 35°C/24°C, and the heating capacity is obtained from the standard test under indoor dry/wet ball temperature of 20°C/15°C and outdoor dry/wet ball temperature of 7°C/6°C. The actual cooling/heating capacity may increase or decrease according to the changes of indoor and outdoor ambient temperatures and relative humidity.

2. Some promotional data is obtained from TICA's national accredited labs. TICA reserves the final interpretation right of above data.

TSA20KRQ

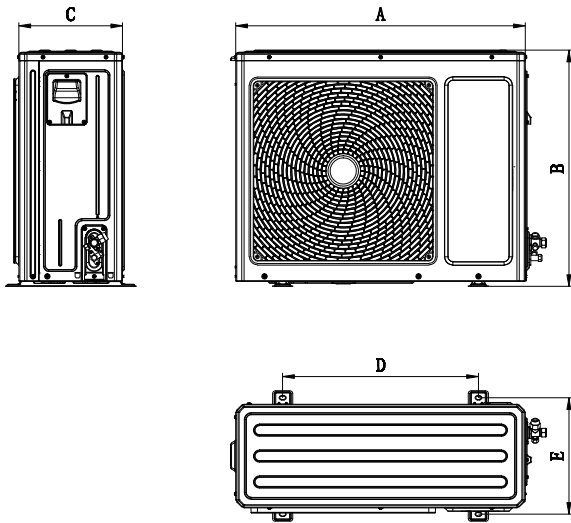

Model	Outer dimensions (unit: mm)				
	A	B	C	D	E
TSA20KRQ	865	700	310	585	350



TSA30KR

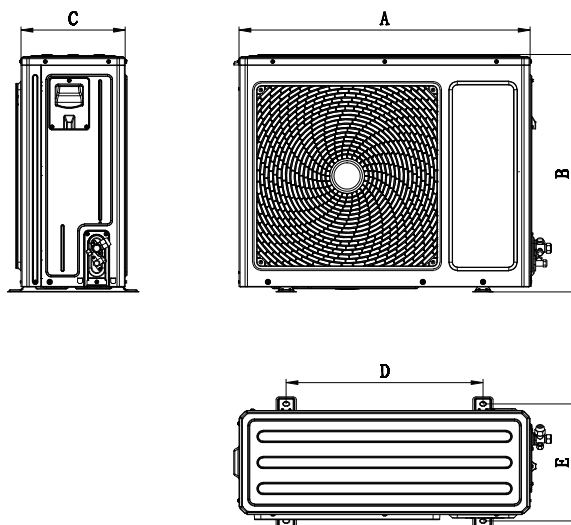

Model	Outer dimensions (unit: mm)				
	A	B	C	D	E
TSA30KR	865	700	310	585	350



TSA50KR/KRT

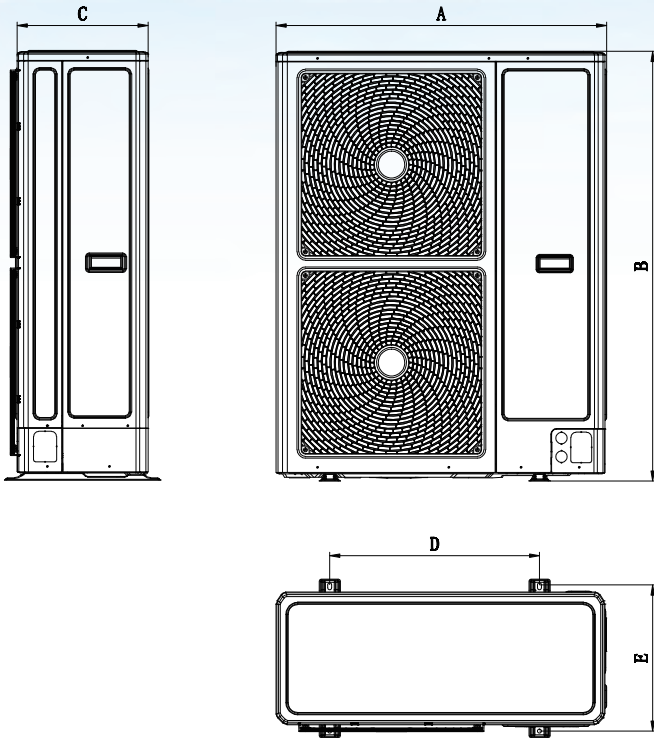

Model	Outer dimensions (unit: mm)				
	A	B	C	D	E
TSA50KR	980	1260	390	625	430
TSA50KRT	980	1260	390	625	430



TSK20KR(D)Q/TSK30KR(D)QE2/TSK50KR(D)QE2/TSK50KR(D)QE3

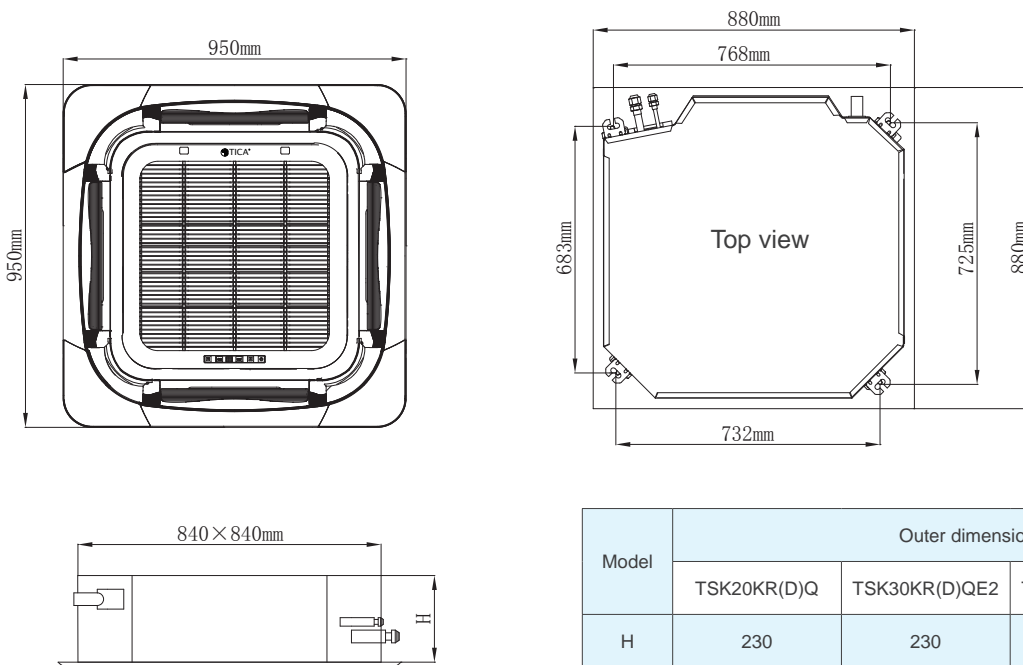

Model	Outer dimensions (unit: mm)			
	TSK20KR(D)Q	TSK30KR(D)QE2	TSK50KR(D)QE2	TSK50KR(D)QE3
H	230	230	300	300

Low static pressure duct unit

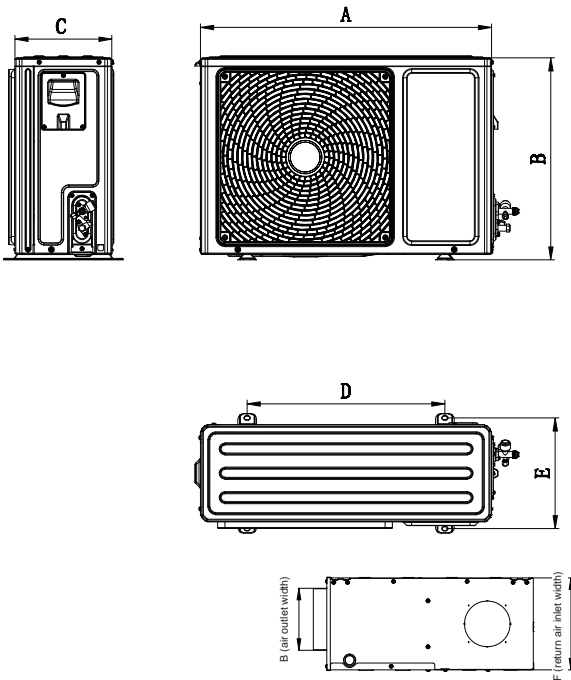

Model	Outer dimensions (unit: mm)				
	A	B	C	D	E
TSA10KR	780	540	260	530	300
TSA15KR	780	540	260	530	300
TSA20KR	780	540	260	530	300
TSA25KR	865	700	310	585	350
TSA30KR	865	700	310	585	350

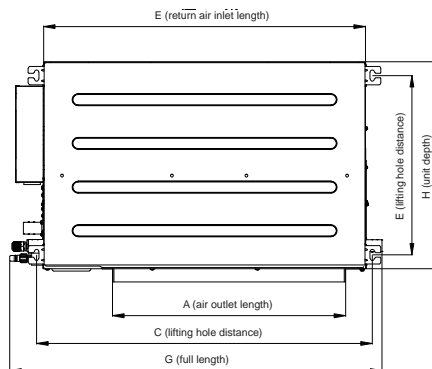
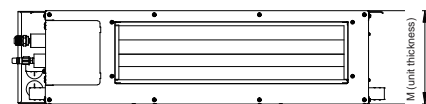

Model	Outer dimensions (unit: mm)								
	A	B	C	D	E	F	G	H	M
TSR10KR(D)C	510	135	730	390	700	200	810	450	200
TSR15KR(D)C	510	135	730	390	700	200	810	450	200
TSR20KR(D)C	730	135	950	390	920	200	1030	450	200
TSR25KR(D)C	950	135	1170	390	1140	200	1250	450	200
TSR30KR(D)CE1	950	135	1170	390	1140	200	1250	450	200

ODU dimensions - Medium static pressure duct unit

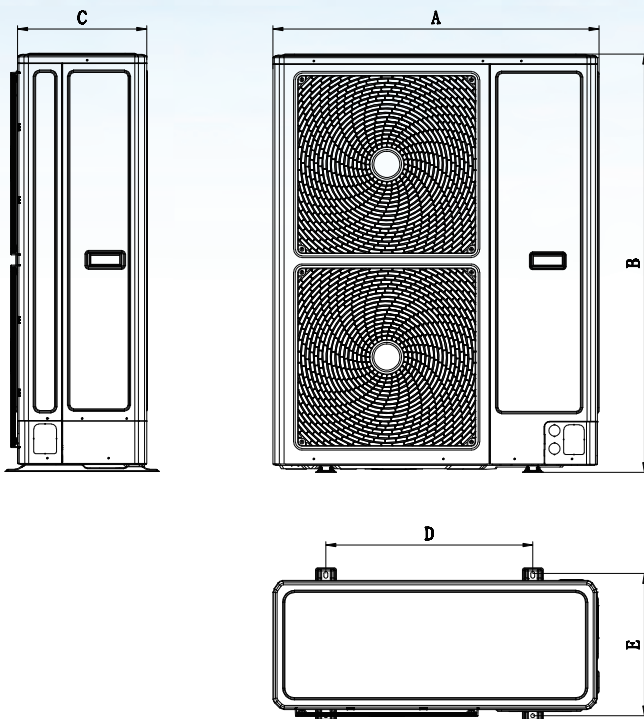

Model	Outer dimensions (unit: mm)				
	A	B	C	D	E
TSA50KR	980	1260	390	625	430
TSA50KRT	980	1260	390	625	430
TSA60KRT	980	1260	390	625	430



ODU dimensions - High static pressure duct unit

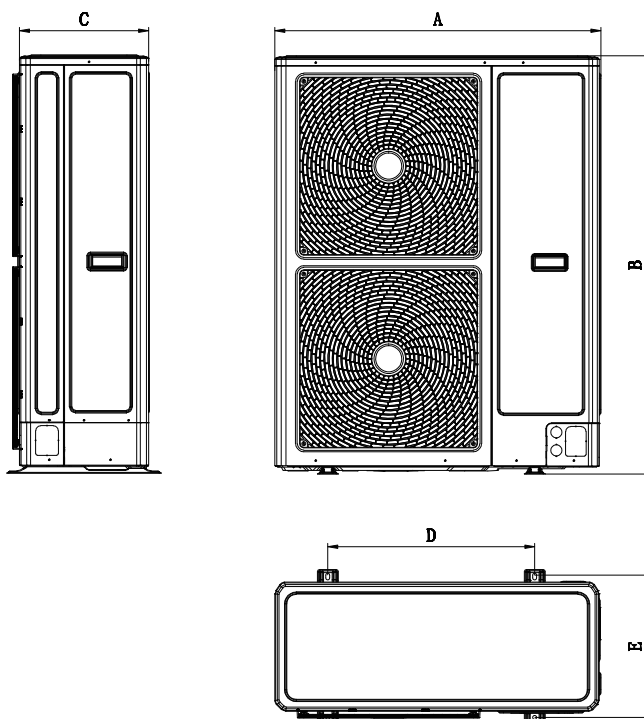

Model	Outer dimensions (unit: mm)				
	A	B	C	D	E
TSA50KR	980	1260	390	625	430
TSA60KRT	980	1260	390	625	430



Medium static pressure duct unit

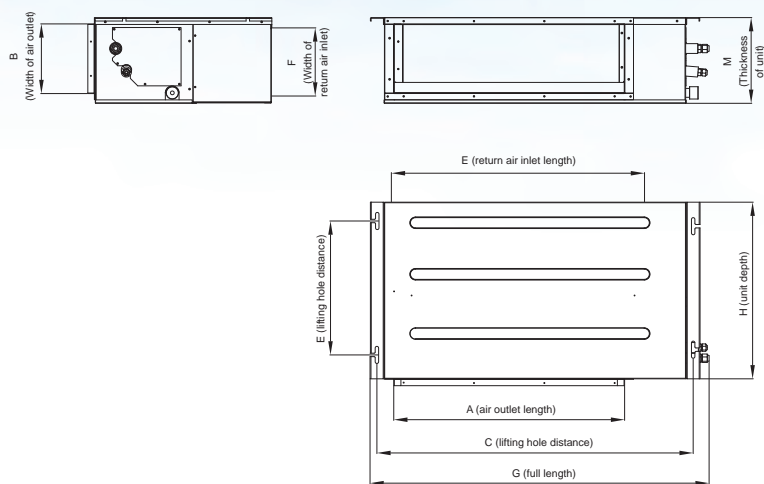

Model	Outer dimensions (unit: mm)								
	A	B	C	D	E	F	G	H	M
TSR50KR(D)BE1	1143	242	1390	329	1208	241	1458	557	292
TSR50KR(D)BE2	1143	242	1390	329	1208	241	1458	557	292
TSR60KR(D)BE2	1143	242	1390	329	1208	241	1458	557	292

High static pressure duct unit

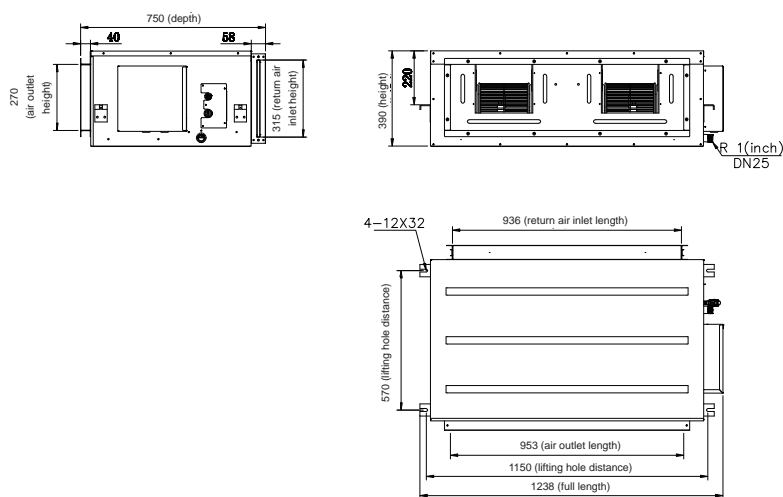

Model	Outer dimensions (unit: mm)								
	A	B	C	D	E	F	G	H	M
TSR50KR(D)HE2	953	319	1150	570	936	270	1230	750	390
TSR60KR(D)HE2	953	319	1150	570	936	270	1230	750	390

Wide application

Internet bar



Chain hotel



Indoor amusement park



Club



Snack bar



Restaurant



Supermarket





TICA[®]
www.tica.pro



TICA CLIMATE
SOLUTIONS
**Light Commercial
Air Conditioner**

«TICA PRO» LLC
tel: +7 495 127 79 00,
+7 915 650 85 85
e-mail: info@tica.pro
www.tica.pro