

INSTALLATION & OPERATION MANUAL

INVERTER MULTI SYSTEM UNIT

Applicable to: TIMS-X/XA/XT/C series

Contents

Safety Precautions	5
Installation of ODU	6
Dimension.....	8
Installation space	10
Handling.....	14
Placement.....	15
Installation of Refrigerant Piping	17
Precautions for the installation of piping:.....	19
The choice of the refrigerant pipe diameter	25
Installation of branch pipes	27
Refrigerant piping length.....	33
Air Tightness Test, Vacuuming and Supplementing Refrigerant	34
Air tightness test	34
Vacuumizing:	34
Supplementing refrigerant.....	36
Electric Control Installation	37
Wiring cautions	37
Wiring specifications	38
Electrical wiring	50
Communication wiring.....	50
ODU Control Panel	51
Code settings.....	51
Settings of relevant keys	55
Digital display.....	57
Trial Operation	59
Before trial operation.....	59
Trial operation.....	59
Trial operation check.....	60
Description of Hazardous Substances	61

Application Form for Debugging Inverter VRF Air Conditioning Unit (Filled by Installer)

Full name of the installer: _____

Address of the installer: _____

Owner's name or employer: _____

Person to contact: _____ Tel: _____

Installation site: _____ Province _____ City _____

Unit model: _____

IDU bar code: _____

ODU bar code: _____

Distributor: _____ Person to contact: _____

Tel: _____ Fax: _____

Installer: _____ Person to contact: _____

Tel: _____ Fax: _____

The following items are to be filled by the installer correctly and faxed to TICA Factory 400 Center 48 hours before boot debugging, so that the debugging can be arranged in due time.

Tel.: +7 495 127 79 00, +7 969 190 85 85

In case the form contents are different from the real situation, causing the experts unlikely to conduct debugging on site, the installer must be liable for labor and travelling expenses incurred to the debugging experts.

Contents to be Checked and Confirmed by Installer

Before installation, ask the installer to carefully read through the manuals and relevant requirements attached to the unit.

1. Check installation position

- | | | |
|--|---------|--------|
| a. Whether heat dissipation and ventilation for ODU meets requirements for distance | Yes () | No () |
| b. Whether ODU is installed on a base firmly and with vibration damping measures applied | Yes () | No () |
| c. Whether IDU is provided with vibration damping measures and properly fastened | Yes () | No () |
| d. Whether there is space for maintenance | Yes () | No () |

2. Check electrical system before installation

- | | | |
|---|---------|--------|
| a. Whether air switch capacity and power wire diameter meet unit requirements | Yes () | No () |
| b. Whether correctly wired and whether wiring terminal is pressed and completely connected | Yes () | No () |
| c. Whether neutral line and grounding wire are connected in accordance with electrical codes | Yes () | No () |
| d. Whether the distribution of control wire and power wire meets anti-interference requirements | Yes () | No () |
| e. Whether the length of control wire and power wire is proper | Yes () | No () |

3. Check refrigerating system before installation

- | | | |
|---|---------|--------|
| a. Whether refrigerant duct meets factory requirements in terms of its diameter and thickness | Yes () | No () |
| b. Whether the length of refrigerant duct meets relevant requirements | Yes () | No () |
| c. Whether added nitrogen for welding refrigerant duct to protect air conditioning unit | Yes () | No () |
| d. Whether cleaned refrigerant duct | Yes () | No () |
| e. Whether used nitrogen for holding pressure to test leakage | Yes () | No () |
| f. Whether vacuumized refrigerating system against installation manual | Yes () | No () |
| g. Whether supplemented refrigerant according to standard | Yes () | No () |

Application Form for Debugging Inverter VRF Air Conditioning Unit (Filled by Installer)

4. Check air duct system before installation	
a. Whether the installation of air duct system is designed by professionals	Yes () No ()
b. Whether external residual pressure matched actual resistance of air duct	Yes () No ()
c. Whether air duct system is provided with static pressure box for air supply and return	Yes () No ()
d. Whether air flow organization of indoor air supply and return is reasonable	Yes () No ()
e. Whether air duct is insulated	Yes () No ()
f. Whether air valve is reasonably set	Yes () No ()
g. Whether return air inlet or IDU is equipped with clean filter	Yes () No ()
h. Whether equipped with air return duct in the case of ceiling air return	Yes () No ()
i. Whether there is fresh air device	Yes () No ()
j. Air supply and return mode: 1 bottom air supply and side air return; 2 side air supply and side air return	Yes ()
5. Check indoor condensate water system before installation	
a. Pour water into drain pan to check whether condensate water could be discharged smoothly and whether there is leakage	Yes () No ()
b. Check whether condensate water pipe is tightly sealed to prevent condensation on the surface of pipe	Yes () No ()
c. Whether water trap is designed in accordance with the manual attached to the unit	Yes () No ()
6. Preparation before debugging	
A. Whether power voltage is in the normal range of the unit and whether the three-phase balance is less than 2%	Yes () No ()
b. Ensure the power is not temporary	Yes () No ()
d. Whether the clients and Party A's inspection experts are in place in time	Yes () No ()
e. Whether there are sufficient facilities (ladder and lifting table) to ensure normal work of operators	Yes () No ()
f. Whether the unit is pre-heated for 24 hours before powering on for debugging	Yes () No ()
7. Other circumstances	
Date of requiring debugging: by ___MM___DD___YYYY	
Applicant (seal):	
Signature:	Date:

Safety Precautions

 **Caution:** Read this manual carefully before installation and use of the unit. The following standard is applied to this product

This installation manual is applied to TICA TIMS-X/XT/XA/XC series R410A refrigerant inverter VRF air (cooling only) conditioning units. The manual is subject to change based on improvement on air conditioners without further notice.

Preparation installation

- Installation shall be left to a licensed professional. Users shall not install, repair or displace the air conditioning unit by themselves.
- Be sure to use a dedicated power circuit. Make sure the supply voltage fluctuates within 10% of rated voltage. Power supply should be separate from welding transformer because the latter may cause large voltage fluctuation.
- Get a licensed electrician to install the unit according to national and local power standard, and to check whether line capacity meets requirements and whether power lines are loose or damaged.
- "Electrical control schematic diagram" is attached to the back side of cover plate of ODU control box. Please keep the manual properly for further reference.

before Precautions during installation

- Do not touch heat exchanger fins. Otherwise, it may cause damage to the fins or reduced performance for the unit or finger injury.
- The cover plate for control box must be fastened to prevent incoming of dust and water. The electrical parts must be water-proof and away from water sources, otherwise electric shock or fire may be caused.
- After installation, be sure to make an air tightness check whether there is pipeline leakage.

Precautions for using R410A refrigerant devices

- Please supplement refrigerating system with liquid refrigerant. In the case of gaseous refrigerant, composition of refrigerant in the system may change.
- Do not mix into other refrigerants.
- Do not use the following tools ever used for common refrigerants (such as R22): pipeline pressure test devices, charge hoses, leakage detection devices, refrigerant charge base, and refrigerant recovery devices.
- Make sure to use vacuum pump dedicated for R410A series.

Precautions at trial operation

- When the system is powered on for the first time or after being left unused for a long time, ODU power must be connected 24 hours before use. Otherwise, the compressor may be burnt (make sure the air conditioner is in standby mode at the seasons they are needed most).
- Do not turn on the air conditioner when the panel or protection screen is removed. The moving parts inside the air conditioner may hurt people or other objects.
- Do not touch refrigerant pipeline during operation or just at the end of operation. The pipeline of the air conditioner may be very hot or cold during its operation, which may lead to scald or frostbite.
- Do not turn off power immediately after the unit stops. Wait at least for five minutes to prevent water leakage.
- Please cut off general power supply during seasons the air conditioners are not used to prolong the service life and save energy.
- All the IDUs and ODUs of the same system must be supplied with power simultaneously.

Installation of ODU

Standard mode

The single outdoor unit starts from 8HP and increases with 2HP, up to 34HP

Model	8HP	10HP	12HP	14HP	16HP
	TIMS080-X TIMS080-XA TIMS080-XT TIMS080-XC	TIMS100-X TIMS100-XA TIMS100-XT TIMS100-XC	TIMS120-X TIMS120-XA TIMS120-XT TIMS120-XC	TIMS140-X TIMS140-XA TIMS140-XT TIMS140-XC	TIMS160-X TIMS160-XA TIMS160-XT TIMS160-XC
	18HP	20HP	22HP	24HP	26HP
	TIMS180-X TIMS180-XA TIMS180-XT	TIMS200-X TIMS200-XA TIMS200-XT	TIMS220-X TIMS220-XA	TIMS240-XA	TIMS260-XA
	28HP	30HP	32HP	34HP	
	TIMS280-XA	TIMS300-XA	TIMS320-XA	TIMS340-XA	

Combination

Model	8HP	10HP	12HP	14HP	16HP
Combination	8X/XA/XT/XC	10X/XA/XT/XC	12X/XA/XT/XC	14X/XA/XT/XC	16X/XA/XT/XC
	/	/	/	/	(8+8)X/XA/XT/XC
Mode	18HP	20HP	22HP	24HP	26HP
Combination	18X/XA/XT	20X/XA/XT	22X/XA	24XA	26XA
	(10+8)X/XA/XT/XC	(10+10)X/XA/XT/XC	(12+10)X/XA/XT/XC	(12+12)X/XA/XT/XC	(14+12)X/XA/XT/XC
	/	/	/	/	/
Model	28HP	30HP	32HP	34HP	36HP
Combination	28XA	30XA	32XA	34XA	/
	(14+14)X/XA/XT/XC	(16+14)X/XA/XT/XC	(16+16)X/XA/XT/XC	(18+16)X/XA/XT	(18+18)X/XA/XT
	(16+12)X/XA/XT/XC	(18+12)X/XA/XT	(18+14)X/XA/XT	(20+14)X/XA/XT	/
	(10+10+8)X/XC	(10+10+10)X/XC	(12+10+10)X/XC	(12+12+10)X/XC	(12+12+12)X/XC
Model	38HP	40HP	42HP	44HP	46HP
Combination	(20+18)X/XA/XT	(20+20)X/XA/XT	(22+20)X/XA	(22+22)X/XA	(24+22)X/XA
	(14+12+12)X/XC	(14+14+12)X/XC	(14+14+14)X/XC	(16+14+14)X/XC	(16+16+14)X/XC

Model	48HP	50HP	52HP	54HP	56HP
Combination	(24+24)XA	(26+24)XA	(26+26)XA	(28+26)XA	(28+28)XA
	/	(28+22)XA	(28+24)XA	(30+24)XA	(32+24)XA
	(16+16+14)X/XC	(18+16+16)X	(18+18+16)X	(18+18+18)X	(20+18+18)X
Model	58HP	60HP	62HP	64HP	66HP
Combination	(30+28)XA	(30+30)XA	(32+30)XA	(32+32)XA	(34+32)XA
	(32+26)XA	/	/	/	/
	(20+20+18)X	(20+20+20)X	(22+20+20)X	(22+22+20)X	(22+22+22)X
Model	68HP	70HP	72HP	74HP	76HP
Combination	(34+34)XA	(24+24+22)XA	(24+24+24)XA	(24+24+26)XA	(24+26+26)XA
	/				
	/				
Model	78HP	80HP	82HP	84HP	86HP
Combination	(26+26+26)XA	(26+26+28)XA	(26+26+30)XA	(26+26+32)XA	(28+28+30)XA
Model	88HP	90HP	92HP	94HP	96HP
Combination	(28+30+30)XA	(30+30+30)XA	(30+30+32)XA	(30+32+32)XA	(32+32+32)XA
Model	98HP	100HP	102HP		
Combination	(34+32+32)XA	(34+32+32)XA	(34+34+34)XA		

Maximum quantity of connectable indoor unit

ODU Capacity	8HP	10HP	12HP	14HP	16HP	18HP	20HP
Quantity of connectable IDU	14	16	19	22	23	31	33
ODU Capacity	22HP	24HP	26HP	28HP	30HP	32HP	34HP
Quantity of connectable IDU	34	35	35	36	38	40	42
ODU Capacity	36HP	38	40HP	42HP	44HP	46HP	48HP
Quantity of connectable IDU	44	46	48	50	52	54	56
ODU Capacity	50HP	52HP	54HP	56HP	58HP	60HP	62HP
Quantity of connectable IDU	58	60	62	64	64	64	64
ODU Capacity	64HP	66HP	68HP	70HP	72HP	74HP	76HP
Quantity of connectable IDU	64	64	64	64	64	64	64
ODU Capacity	78HP	80HP	82HP	84HP	86HP	88HP	90HP

Quantity of connectable IDU	64	64	64	64	64	64	64
ODU Capacity	92HP	94HP	96HP	98HP	100HP	102HP	
Quantity of connectable IDU	64	64	64	64	64	64	

Installation of ODU

Dimension

Model: TIMS080- X/XA/XT/XC

TIMS100- X/XA/XT/XC

TIMS120- X/XA/XT/XC

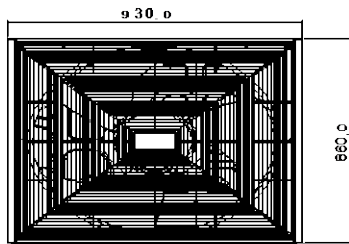
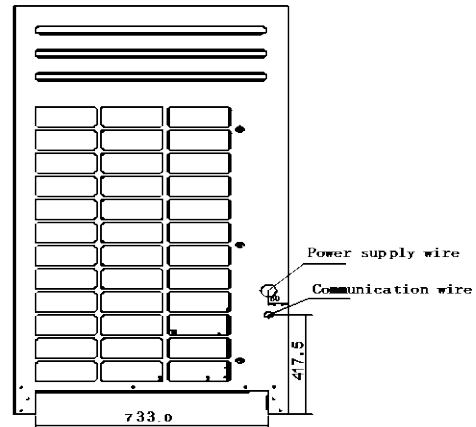
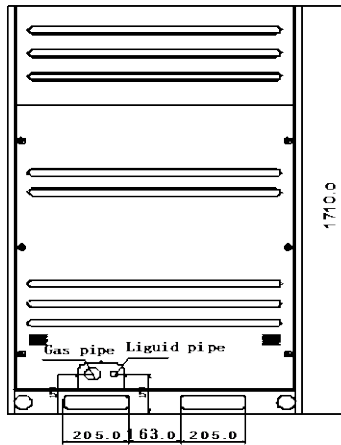

Model: TIMS140- X/XA/XT/XC

TIMS160- X/XA/XT/XC

TIMS180- XA/XT

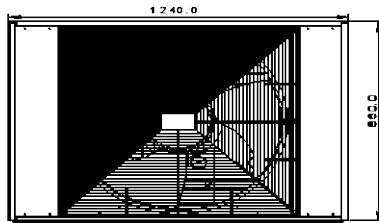
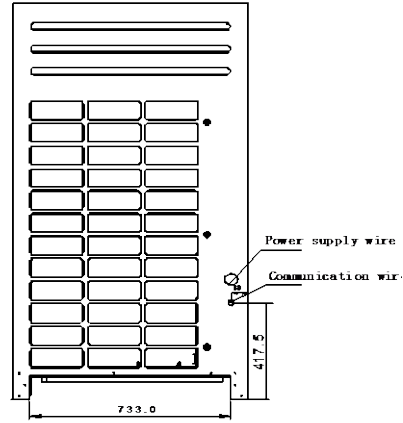
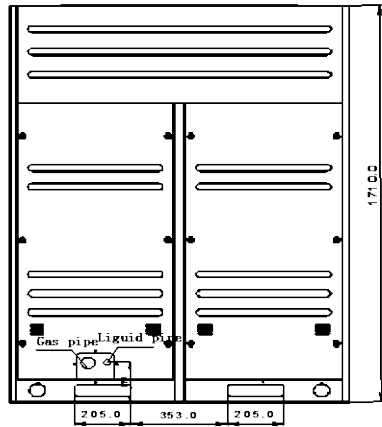

Installation of ODU

Dimension

Model: TIMS180-X TIMS200-X/XA/XT TIMS220-X/XA TIMS240-XA

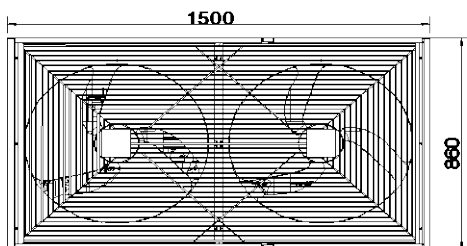
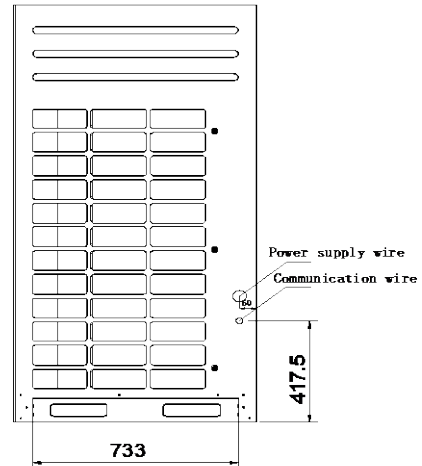
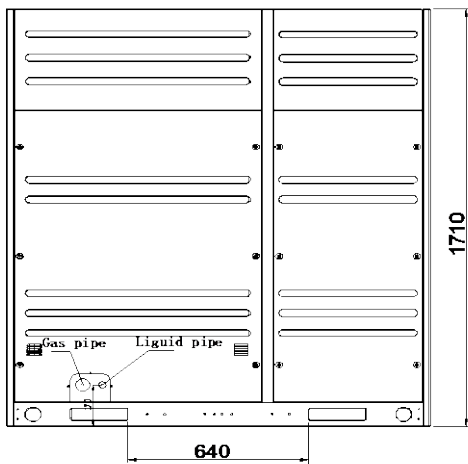

Model: TIMS260-X TIMS280-XA TIMS300-XA TIMS320-XA TIMS340-XA

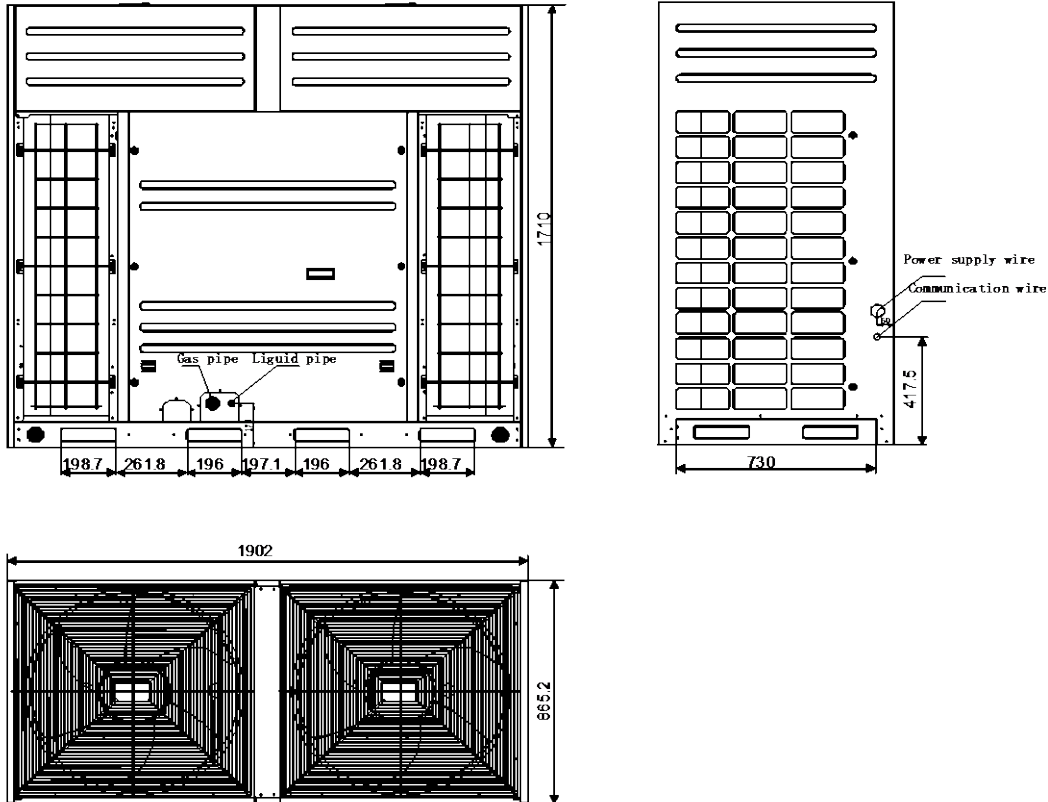

Installation of ODU

Installation space

Requirements for installation position

- The installation position shall have sufficient strength to bear the unit weight and its vibration during operation. If the ODU is installed on a roof, make sure the roof is strong enough and water-proof.
- The ODU shall be installed in a well ventilated place to ensure good heat exchange.
- Places unsuitable for installation:
 - ▲ The place where acid or alkaline substance or corrosive gas(e.g., sulfur dioxide and hydrogen sulfide) may be produced, easily corroding the unit and leading to refrigerant leakage.
- Places where air conditioning units must not be installed
- ▲ The place where flammable gas or volatile combustibles may be produced. If flammable gas leaks and accumulates around the unit, the unit may explode.
 - ▲ Do not install the ODU where it is exposed directly to strong wind or typhoon. When conditions permit, add auxiliary equipment to prevent water, snow or direct sunshine.
 - ▲ Do not install the outdoor unit just below the edge of the roof, to prevent the unit failure caused by the dropping of rubbles or ice particles. If installing the outdoor unit in this position is unavoidable, mount a protective shed above it.

Installation of snow protection facilities

- Install snow protection facilities in the snow area, such as

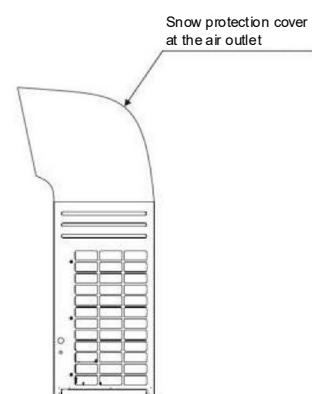

the snow protection cover and shed.

- Inadequate snow protection facilities will result in a high probability of malfunction.
- Appropriately raise the bracket stand to avoid snow accumulation.

Requirements for ODU installation space

- Make sure there is enough space above the unit.
- The side with TICA symbol attached shall be the front side of ODU.
- Make sure that the surrounding walls are not higher than the specified value below:
front: 1500 mm, rear: 500 mm, left and right: unlimited
- Otherwise, the maintenance distances at front or rear side should be increased by $H/2$, as shown in the following figure:

Installation of ODU

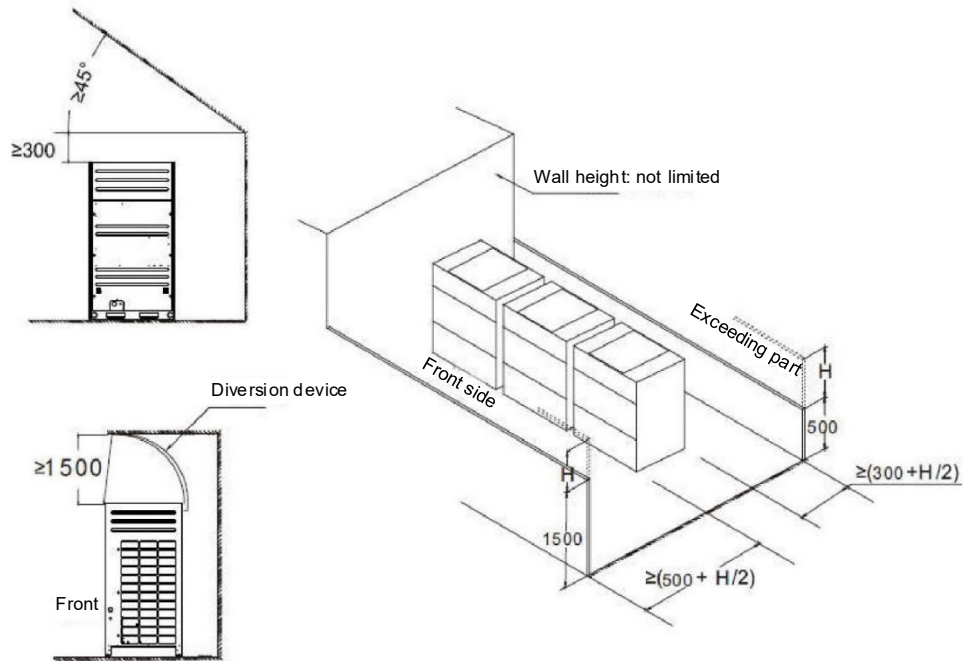

Installation space of a unit:

1. Installation space of a unit

A unit should be installed in space surrounded by walls. The walls at its both sides is unlimited in height.

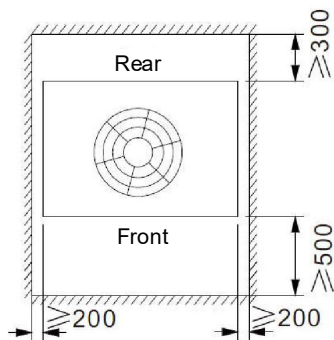

When the front and one side of the ODU are in open areas

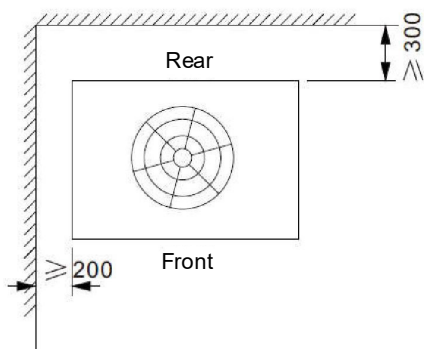

Installation of ODU

2. Unit installation in a single row

The unit should be installed in space surrounded by walls

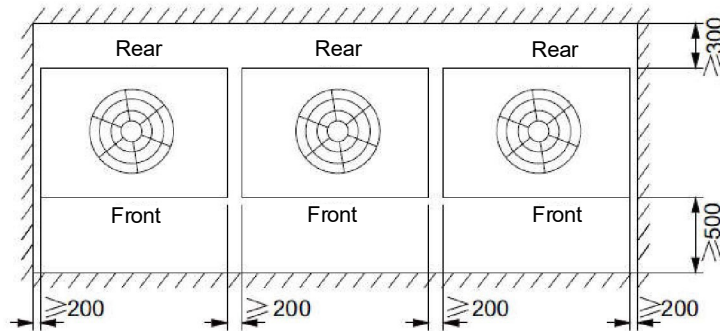

The front and one side of the ODU are in open areas

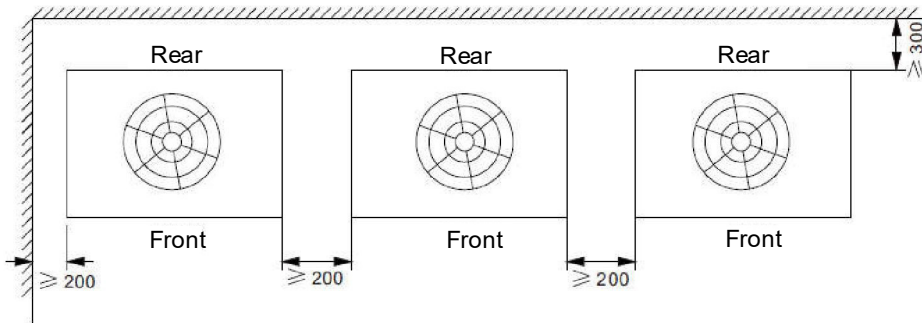

3. ODU Installation in the same direction

space surrounded by walls

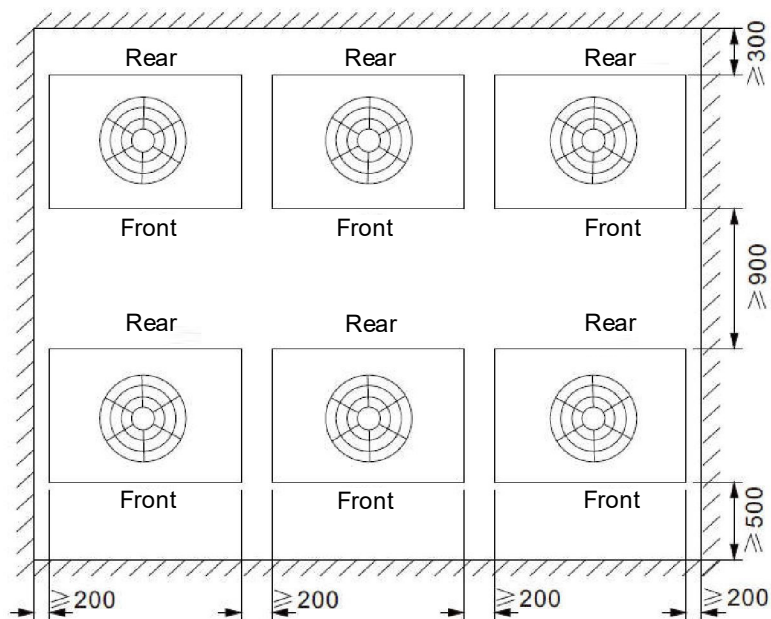

Installation of ODU

The front and one side of the ODU are in open areas

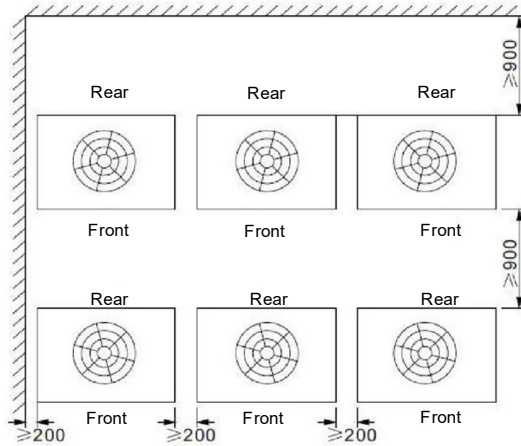

3. Unit installation back to back

The front and one side of the ODU are in open areas

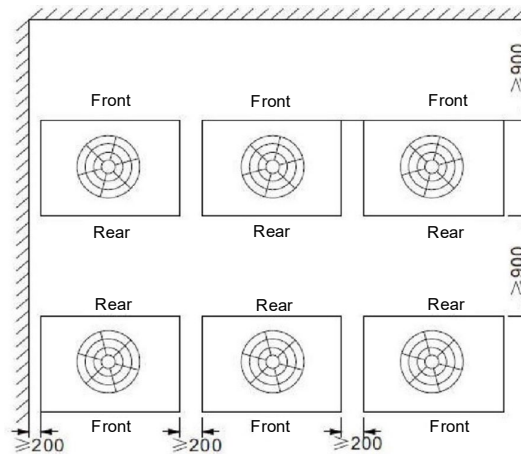

The unit is surrounded by walls

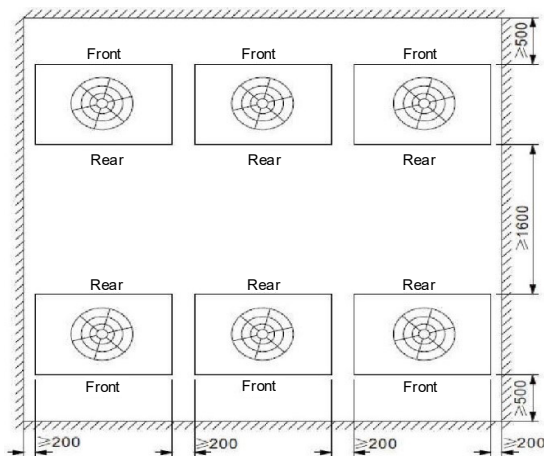

Installation of ODU

Handling

Notes:

- Fragile and handle with care.
- The degree of inclination shall not exceed 30° while handling (do not put the unit on its side).
- Keep heat exchange fins safe while handling and installing the unit. In case of any damages, please use fin comb to fix it up.
- Properly dispose of packaging bags and prevent kids from playing with them.

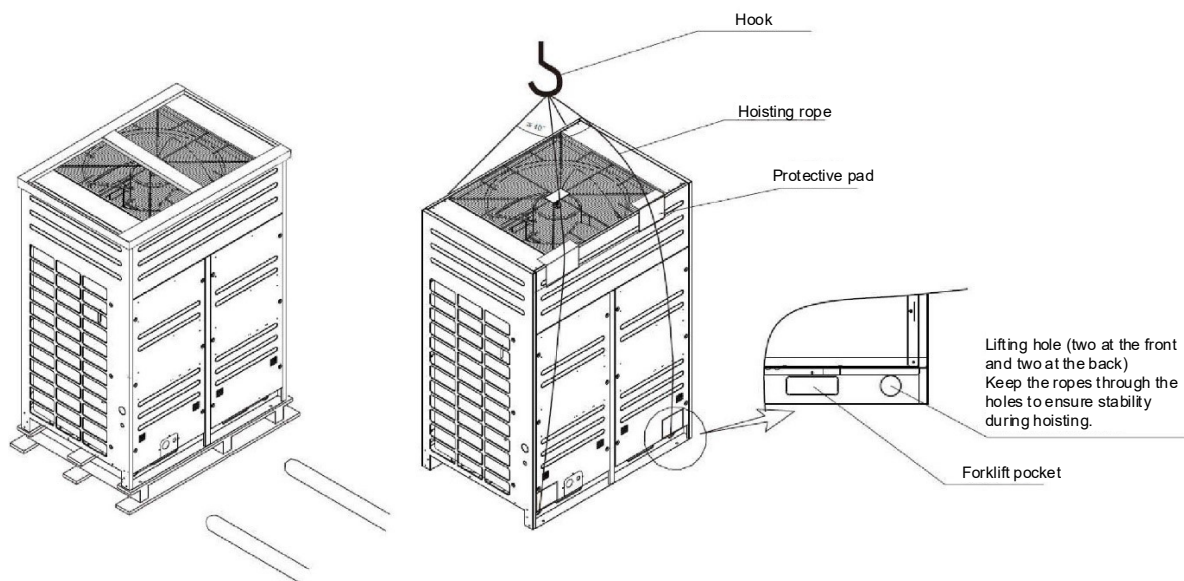

- Use forklift to handle: be careful when inserting the fork into the pocket at the bottom, and prevent fork from damaging the unit or the unit bottom.
- Use crane to handle: tighten hoisting rope according to what is shown in the figure, and keep the unit weight even during hoisting.
- Use two hoisting ropes at least 8 m long and about 20 mm in diameter to support the unit weight. Do not use tying band of the unit for handling.
- After the wooden framework is removed: use paper or cloth as pad between hoisting rope and the unit to prevent damages to the unit body.

Placement

- Make sure the ODU is placed firmly at a level place to prevent vibration and noises.
- Use a base larger than the width of ODU's support legs (66 mm) to support the unit.
- The shock-absorbing pads shall cover the entire bearing surface of the base.
- The unit base shall be at least 200 mm higher above the ground.
- Around the base there should be drain to ensure that the condensate water generated during operation could flow out.

Installation of ODU

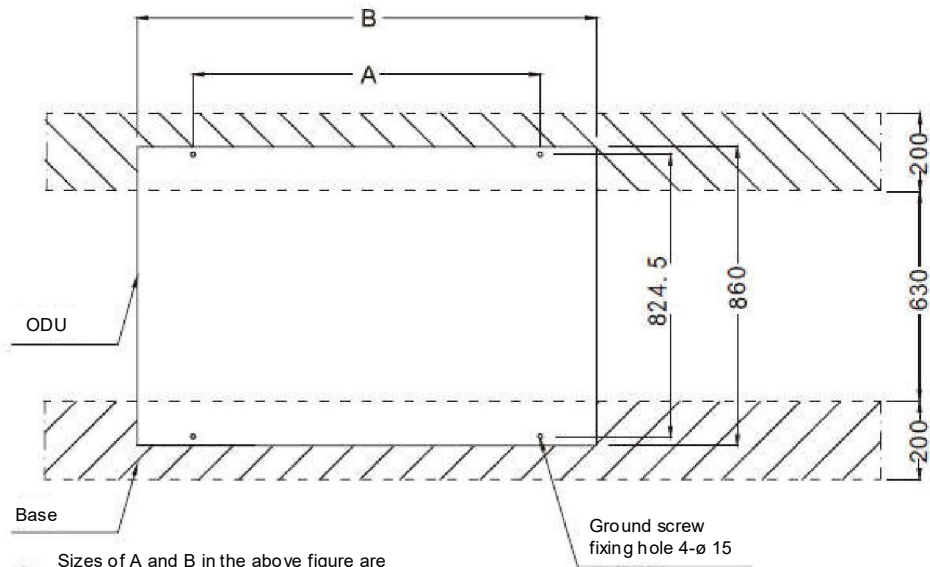

- Sizes of A and B in the above figure are shown in the table below:

Model	A	B
TIMS080-X ~ TIMS120-X TIMS080-XA ~ TIMS120-XA TIMS080-XT ~ TIMS120-XT TIMS080-XC ~ TIMS120-XC	728 mm	930 mm
TIMS140-X ~ TIMS160-X TIMS140-XA ~ TIMS180-XA TIMS140-XT ~ TIMS180-XT TIMS140-XC ~ TIMS160-XC	1038 mm	1240 mm
TIMS180-X ~ TIMS220-X TIMS200-XT TIMS200-XA ~ TIMS240-XA	1375 mm	1500 mm
TIMS260-XA ~ TIMS340-XA	1745 mm	1900 mm

Installation of Refrigerant Piping

- Concrete foundation: the foundation shall be above the ground for at least 150 mm.

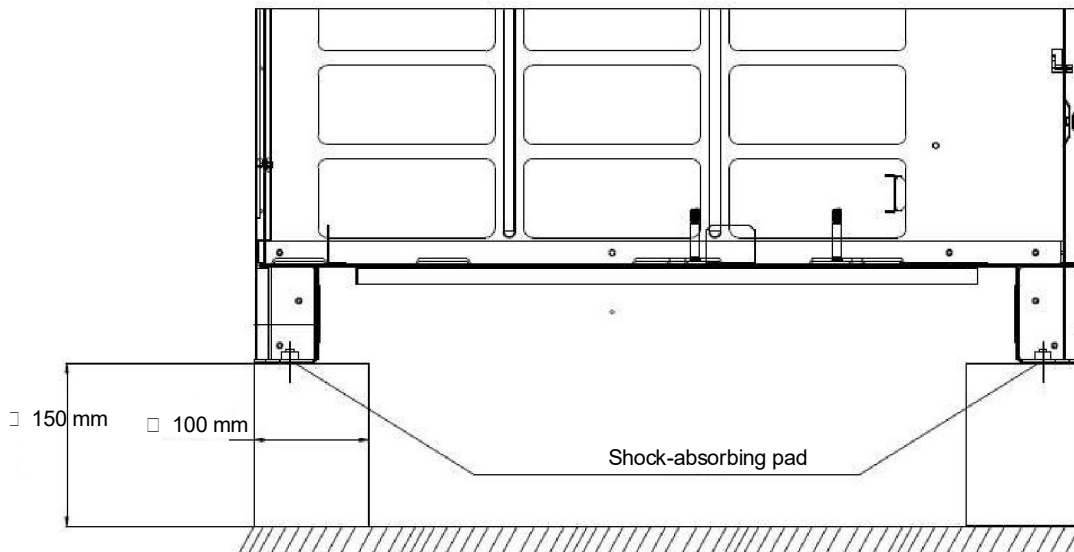

- Use anchor bolts, nuts and pads to fasten the ODU tightly to the base.

Caution: shock-absorbing pads need to cover the entire bottom of the unit, and the pad thickness is greater than or equal to 20 mm.

- For anti-corrosive models: use rubber pads. If the nut joints get loose, the unit will not be corrosion proof.

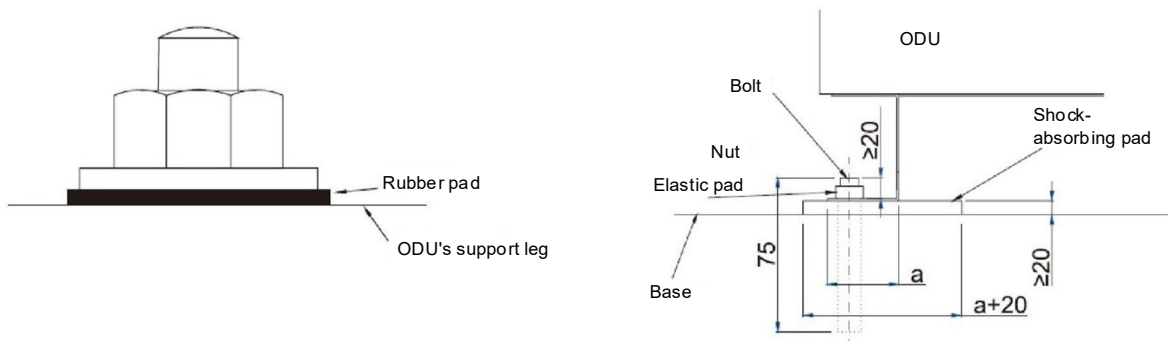

Installation of Refrigerant Piping

Piping connection when the master and slave units are connected in parallel

- The copper pipe for part A in the figure shall have the sizes chosen from the following table based on the total capacity of the ODU at the upper reaches. The copper pipe for part B have the same size as that of the ODU.

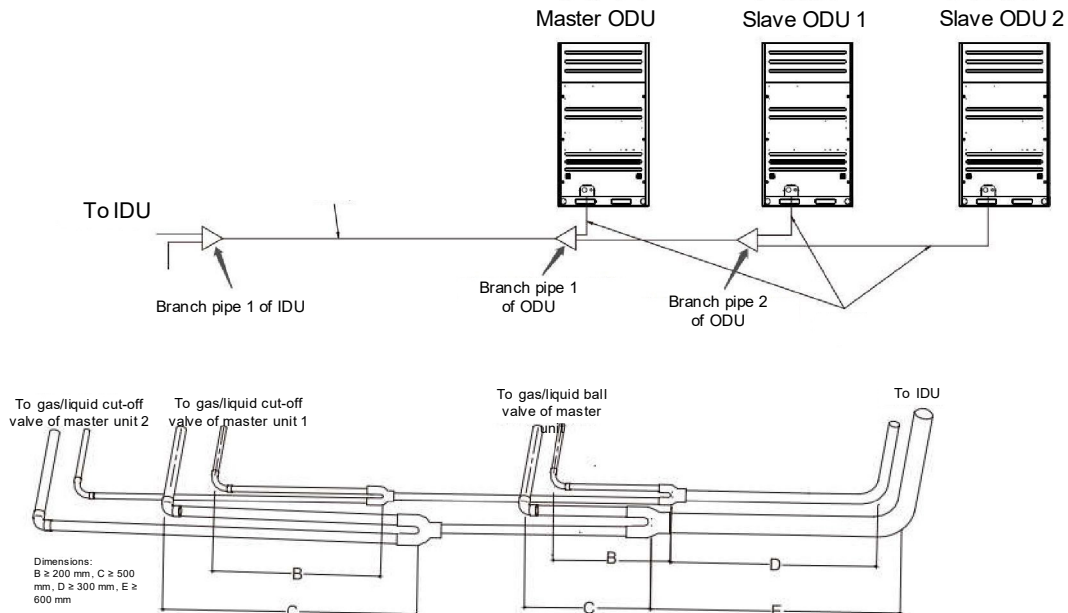

The choice of branch pipes when the ODU is installed in parallel

Total capacity of the ODU (kW)	Model of branch pipes	
	The first branch pipe of the ODU	The second branch pipe of the ODU
Double module		
$X \leq 32\text{HP}$	TBP4090TA	/
$X > 32\text{HP}$	TBP4135TA	/
Triple module		
$X \leq 32\text{HP}$	TBP4135TA	TBP4090TA
$32\text{HP} < X \leq 68\text{HP}$	TBP4135TA	TBP4135TA
$X > 68\text{HP}$	TBP4285TA	TBP4135TA



- The capacity of the installation position (from large to small): master unit \geq slave unit 1 \geq slave unit 2.
- Do not connect a pipe to the charge valve.

Multiple unit of the master and slave units:

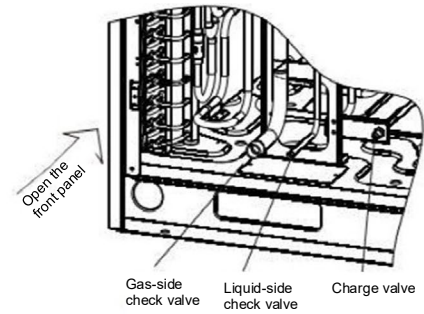
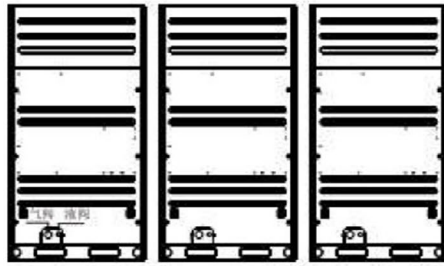

Installation of Refrigerant Piping

Precautions for the installation of piping:

- Use clean piping that is free from dust, moisture or any other substances.
- Store all the pipelines needed for installation indoors, and keep two ends of pipelines sealed till welding.
- Pass copper pipes into the holes at wall and seal the holes to prevent dirt coming in.
- Do not do ODU piping work on rainy days, lest that moisture and dirt would enter the pipelines.
- Try to reduce bended piping and use bends with larger radius.
- When connecting refrigerant piping, the stop valve of ODU shall be closed completely after refrigerant piping between ODU and IDU is done, and refrigerant leakage test and vacuumizing process are finished.

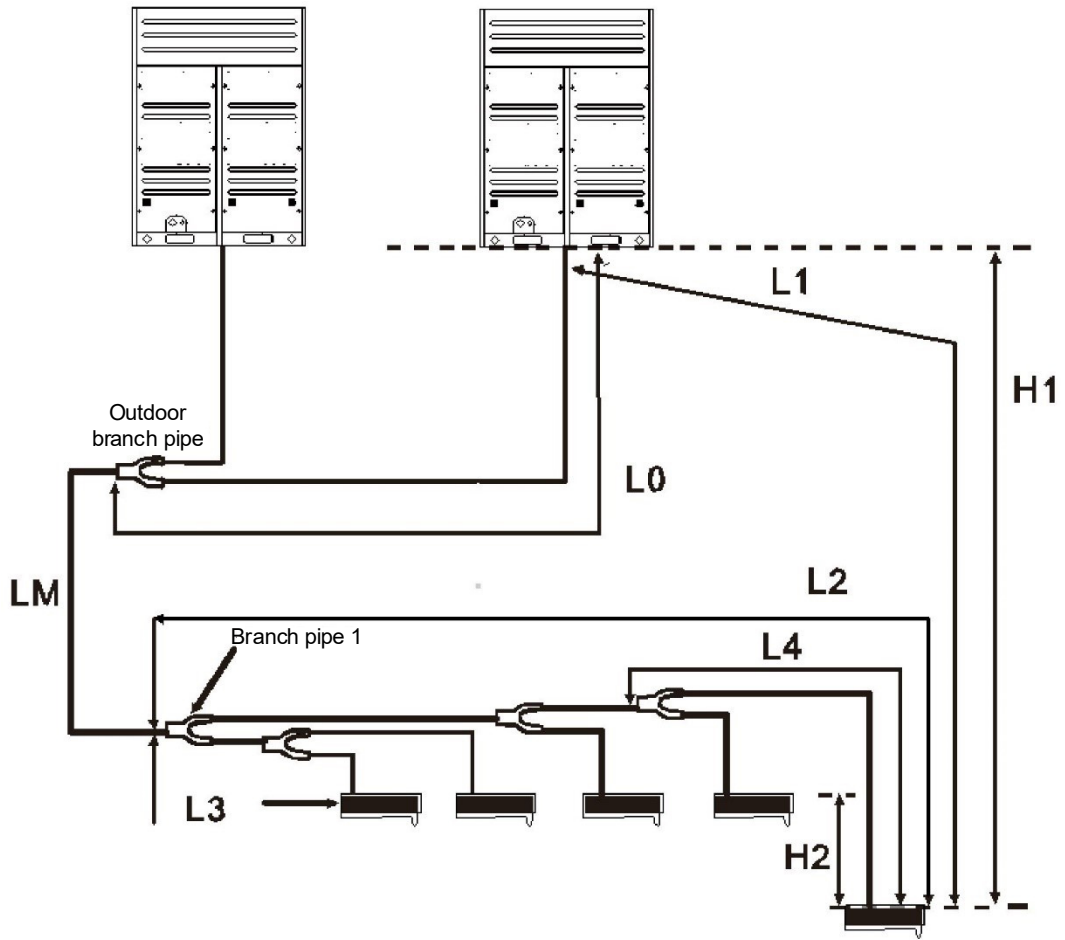

The installation of the outdoor modules:

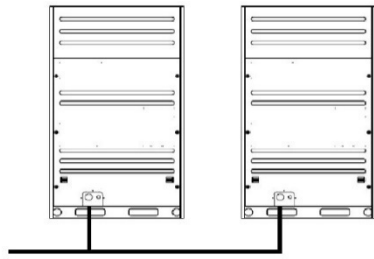

The pipes between the modules are all under the ports and keep horizontal.

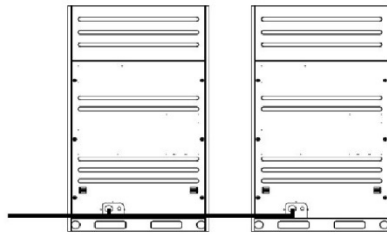

The pipes between the modules keep horizontal with the ports.

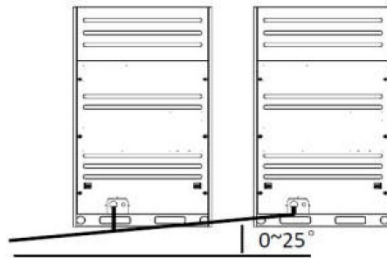

The pipes between the modules are all under the ports and allowed to uptilt from 0° to 25°.

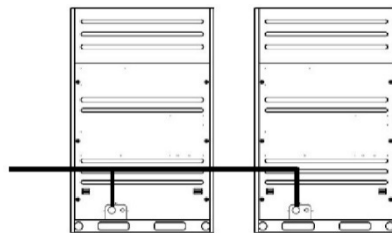

The pipes between the modules are all over the ports.

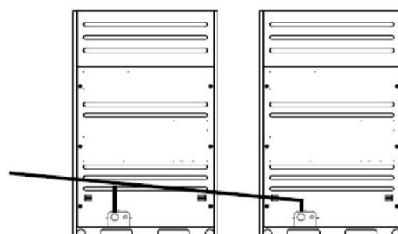

The pipes between the modules are all over the ports.

	Definition	Limit (actual length)	Remarks
H1*1	Level difference between the IDU and ODU	When the ODU is at the upper position: < 50 m When the ODU is at the lower position: < 40 m	
H2*1	Level difference among IDUs	< 20 m	
L0	The distance between the ODU and outdoor branch pipe	< 10 m	
L1	The piping length between the ODU and the farthest IDU.	< 165 m (Equivalent length 190 m)	Over 90 m: Liquid/Gas pipe size should be increased by one level (Except liquid main pipe ≤ 10 HP)
LM*2	Main pipe length	< 90 m	Over 40 m: Main gas pipe size should be increased by one level
L2	The distance from the farthest IDU to the first branch pipe of the IDU.	< 40 m	> 40 m: Increase the size of main pipe by one
L3	Distance from the IDU to the nearest branch pipe	< 40 m	
L2-L3	(Longest piping distance from the IDU to the first branch pipe on the indoor side) - (Shortest piping distance from the IDU to the first branch pipe on the indoor side)	< 40 m	
L4*4	Distance from the IDU from nearest branch pipe	< 40 m	
Total L	Total length of piping (total length of all liquid pipes or gas pipes of the system)	Equivalent length < 1000 m	1 modules: below 400m 2 modules: below 600 m 3 modules: below 1000m Total refrigerant amount: below 100 kg ³

*1: Contact TICA's engineers when exceeding the above limits.

*2: If it exceeds 40 m, the remarks on the next page shall be met.

*3: If it exceeds 90 m, refer to Selection of refrigerant piping diameters

*4: The total refrigerant quantity of the unit (≤ 32 HP) should not be greater than 52.0 kg, and that of the 34 HP unit should not be greater than 60.0 kg. Otherwise, the unit may fail to operate safely and reliably. Please consult TICA's engineers for details.

Determination of diameter of branch pipe of the IDU

The IDU is equipped with branch pipes h~p. Refer to the following table for the selection of the branch pipe size. Unit: mm

IDU capacity	When the length of the branch pipe ≤ 10 m or distance from the IDU from nearest branch pipe < 20 m (outer diameter x minimum wall thickness)		When the length of the branch pipe > 10 m or distance from the IDU from nearest branch pipe > 20 m (outer diameter x minimum wall thickness)	
	Gas side	Liquid side	Gas side	Liquid side
A (x100W)				
A < 71	$\phi 12.7 \times 0.8$	$\phi 6.35 \times 0.8$	$\phi 15.9 \times 1.0$	$\phi 9.5 \times 0.8$
A ≥ 71	Piping according to the normal pipe diameter			

Note: In order to ensure the best use effect of the IDU, control the length of the branch pipe within 10 m (shall not exceed 30 m), otherwise the indoor heat exchange effect will be affected.

Installation of Refrigerant Piping

Remarks: The equivalent longest piping distance from the IDU to components of the first branch pipe shall be no more than 40 m. However, when all the following conditions are met, it is allowed to extend the length to 90 m. (in the case of "using TICA branch pipe".)

Required conditions	Legends	
1. The diameter of the pipe between the components of the first branch pipe and those of the last branch pipe needs to be increased. (Make the variable diameter pipe on the site); If the piping diameter is the same with that of the main pipe, it does not need to be increased.	$b + c + d + e + f + g + p \leq 90 \text{ m}$; The piping diameters of b, c, d, e, f, g need to be increased	The piping size shall be increased as follows $\Phi 9.5 \rightarrow \Phi 12.7$ $\Phi 12.7 \rightarrow \Phi 15.9$ $\Phi 15.9 \rightarrow \Phi 19.1$ $\Phi 19.1 \rightarrow \Phi 22.2$ $\Phi 22.2 \rightarrow \Phi 25.4$ $\Phi 25.4 \rightarrow 28.6$ $\Phi 28.6 \rightarrow \Phi 31.8$ $\Phi 31.8 \rightarrow \Phi 34.9$ $\Phi 34.9 \rightarrow \Phi 38.1$
2. When calculating the total extension length, the actual length of the preceding pipes must be doubled. (except for main pipe and pipes without increased pipe diameter.)	$a + b \times 2 + c \times 2 + d \times 2 + e \times 2 + f \times 2 + g \times 2 + h + i + j + k + l + m + n + p \leq 1000 \text{ m}$	
3. Distance from the IDU to the nearest branch pipe component $\leq 40 \text{ m}$	$h, i, j, l, k, m, n, p \leq 40 \text{ m}$	
4. Distance difference between (the ODU to the farthest IDU) and (the ODU to the nearest IDU) $\leq 40 \text{ m}$	The farthest IDU $\boxed{8}$ The nearest IDU $\boxed{1}$ Farthest IDU-nearest IDU $(a+b+c+d+e+f+g+p) - (a+h) \leq 40 \text{ m}$	

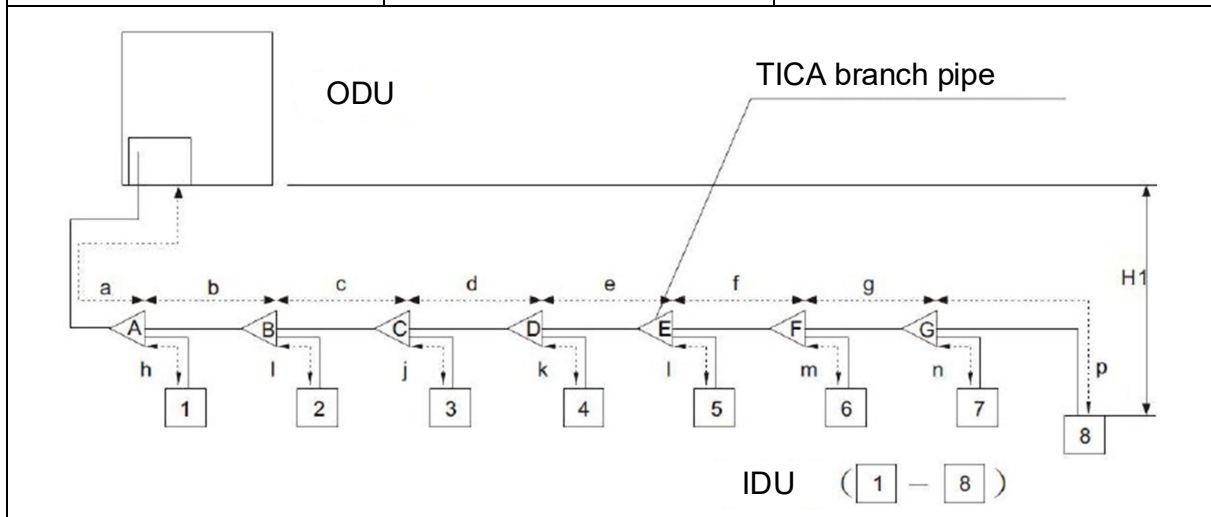

Installation of Refrigerant Piping

Direct selection of refrigerant piping

The copper pipe for main pipelines (LM) shall have the sizes chosen from the following table based on the total capacity of ODUs at the upper reaches (the ones unlabeled can be generally applied)

ODU capacity (HP)	Piping length (LM + L1) < 90 m Main pipe length (LM) < 40 m		Piping length (LM + L1) < 90 m Main pipe length (LM) > 40 m		Piping length (LM + L1) > 90 m	
	Liquid pipe (mm)	Gas pipe (mm)	Liquid pipe (mm)	Gas pipe (mm)	Liquid pipe (mm)	Gas pipe (mm)
	8	9.52 12.7(-X/XC)	22.23 25.4(XC)	9.52 12.7(-X/XC)	25.4 28.58(XC)	12.7 15.88(-X/XC)
10	9.52 12.7(-X/XC)	22.23 25.4(XC)	9.52 12.7(-X/XC)	25.4 28.58(XC)	12.7 15.88(-X/XC)	25.4 28.58(XC)
12	12.7	25.4	12.7	28.58	15.88	28.58
14	12.7	28.58	12.7	31.75	15.88	31.75
16	12.7	28.58	12.7	31.75	15.88	31.75
18	12.7 15.88(-X)	28.58	12.7 15.88(-X)	31.75	15.88 19.05(-X)	31.75
20	15.88	28.58	15.88	31.75	19.05	31.75
22	15.88	28.58	15.88	31.75	19.05	31.75
24	15.88 19.05(-X)	28.58 31.75(-X)	15.88 19.05(-X)	31.75 34.92(-X)	19.05 22.23(-X)	31.75 34.92(-X)
26	19.05	31.75	19.05	34.92	22.23	34.92
28	19.05	31.75	19.05	34.92	22.23	34.92
30	19.05	31.75	19.05	34.92	22.23	34.92
32	19.05	31.75	19.05	34.92	22.23	34.92
34	19.05	34.92	19.05	38.1	22.23	38.1
36	19.05	34.92	19.05	38.1	22.23	38.1
38	19.05	34.92	19.05	38.1	22.23	38.1
40	19.05	38.1	19.05	41.3	22.23	41.3
42	19.05	38.1	19.05	41.3	22.23	41.3
44	19.05	38.1	19.05	41.3	22.23	41.3
46	19.05	38.1	19.05	41.3	22.23	41.3
48	19.05	38.1	19.05	41.3	22.23	41.3
50	22.23 19.05(-X)	41.3	22.23 19.05(-X)	41.3	22.23	41.3

Installation of Refrigerant Piping

Direct selection of refrigerant piping

The copper pipe for main pipelines (LM) shall have the sizes chosen from the following table based on the total capacity of ODU's at the upper reaches (the ones unlabeled can be generally applied)

ODU capacity (HP)	Piping length (LM + L1) < 90 m Main pipe length (LM) < 40 m		Piping length (LM + L1) < 90 m Main pipe length (LM) > 40 m		Piping length (LM + L1) > 90 m	
	Liquid pipe (mm)	Gas pipe (mm)	Liquid pipe (mm)	Gas pipe (mm)	Liquid pipe (mm)	Gas pipe (mm)
52	22.23 19.05(-X)	41.3	22.23 19.05(-X)	41.3	22.23	41.3
54	22.23 19.05(-X)	41.3	22.23 19.05(-X)	41.3	22.23	41.3
56	22.23 19.05(-X)	41.3	22.23 19.05(-X)	41.3	22.23	41.3
58	22.23 19.05(-X)	41.3	22.23 19.05(-X)	41.3	22.23	41.3
60	22.23 19.05(-X)	41.3	22.23 19.05(-X)	41.3	22.23	41.3
62	22.23 19.05(-X)	41.3	22.23 19.05(-X)	41.3	22.23	41.3
64	22.23 19.05(-X)	41.3	22.23 19.05(-X)	41.3	22.23	41.3
66	22.23 19.05(-X)	41.3	22.23 19.05(-X)	41.3	22.23	41.3
68	22.23	41.3	22.23	41.3	22.23	34.92
70	22.23	44.5	22.23	54.0	25.4	54.0
72	22.23	44.5	22.23	54.0	25.4	54.0
74	22.23	44.5	22.23	54.0	25.4	54.0
76	22.23	44.5	22.23	54.0	25.4	54.0
78	22.23	44.5	22.23	54.0	25.4	54.0
80	22.23	44.5	22.23	54.0	25.4	54.0
82	22.23	44.5	22.23	54.0	25.4	54.0
84	22.23	44.5	22.23	54.0	25.4	54.0
86	22.23	44.5	22.23	54.0	25.4	54.0
88	22.23	44.5	22.23	54.0	25.4	54.0
90	22.23	44.5	22.23	54.0	25.4	54.0
92	22.23	44.5	22.23	54.0	25.4	54.0
94	22.23	44.5	22.23	54.0	25.4	54.0
96	22.23	44.5	22.23	54.0	25.4	54.0

Installation of Refrigerant Piping

- The piping between the last-level branch pipe and IDU should have the same size with the IDU connecting pipe.
- The pipe between branch pipes should be based on the total capacity of downstream IDUs connected to the pipe.

Total capacity of connected IDUs (kw)	Liquid Pipe Specifications (mm)	Gas Pipe Specifications (mm)
$X < 16.8$	Φ 9.52	Φ15.88
$16.8 \leq X < 22.5$	Φ9.52	Φ19.05
$22.5 \leq X < 33.0$	Φ9.52	Φ22.23
$33.0 \leq X < 46.0$	Φ12.7	Φ25.40
$46.0 \leq X < 67.0$	Φ15.88	Φ28.58
$67.0 \leq X < 86$	Φ19.05	Φ31.75
$86.0 \leq X < 114.0$	Φ19.05	Φ34.92
$114.0 \leq X < 140.0$	Φ19.05	Φ38.1
$140.0 \leq X < 180.0$	Φ19.05	Φ41.3
$X \geq 180.0$	Φ22.23	Φ44.5

Remarks: The size of the piping between branch pipes shall not be greater than that of the cooper pipe of the main pipe in the figure above.

Installation of branch pipes

- Branch pipes should be selected based on the total capacity of downstream IDUs connected:

Total capacity of downstream IDUs connected to branch pipes (kw)	Model of branch pipes
$X < 16.8$	TBP4022TA
$16.8 \leq X < 22.5$	TBP4022TA
$22.5 \leq X < 33.0$	TBP4033TA
$33.0 \leq X < 46.0$	TBP4072TA
$33.0 \leq X < 46.0$	TBP4072TA
$X \geq 67.0$	TBP4073TA



For branch pipe component installation, the model of branch pipe components and the diameters of connected main pipe and branch pipe should be confirmed according to the construction drawings and installation instructions. There should not be sharp turns (90° angle) or other branch pipe components falling within 500 mm of branch pipe components. The straight pipe distance between two adjacent branch pipes should not be less than 1000 mm.

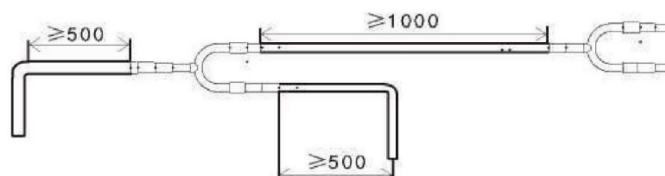

Installation of Refrigerant Piping

- ⚠ Branch pipes can be vertically or horizontally installed and as close as possible to the IDU. When installed horizontally, the angle shall be between $\pm 15^\circ$.

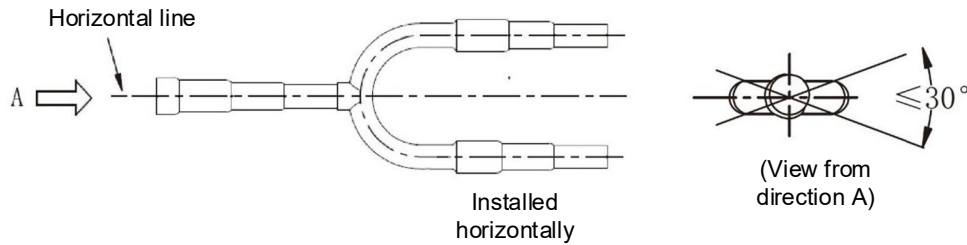

See the following figure when branch pipes are installed vertically:

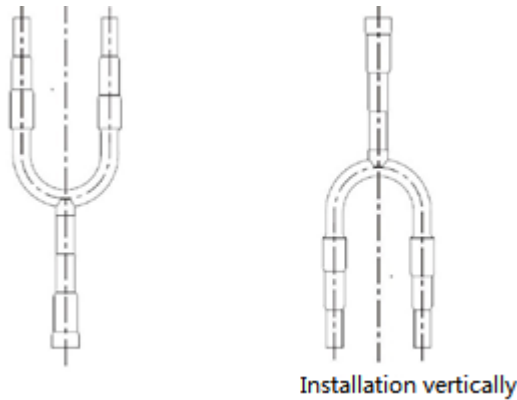

- Size of branch pipes:
TBP4022TA

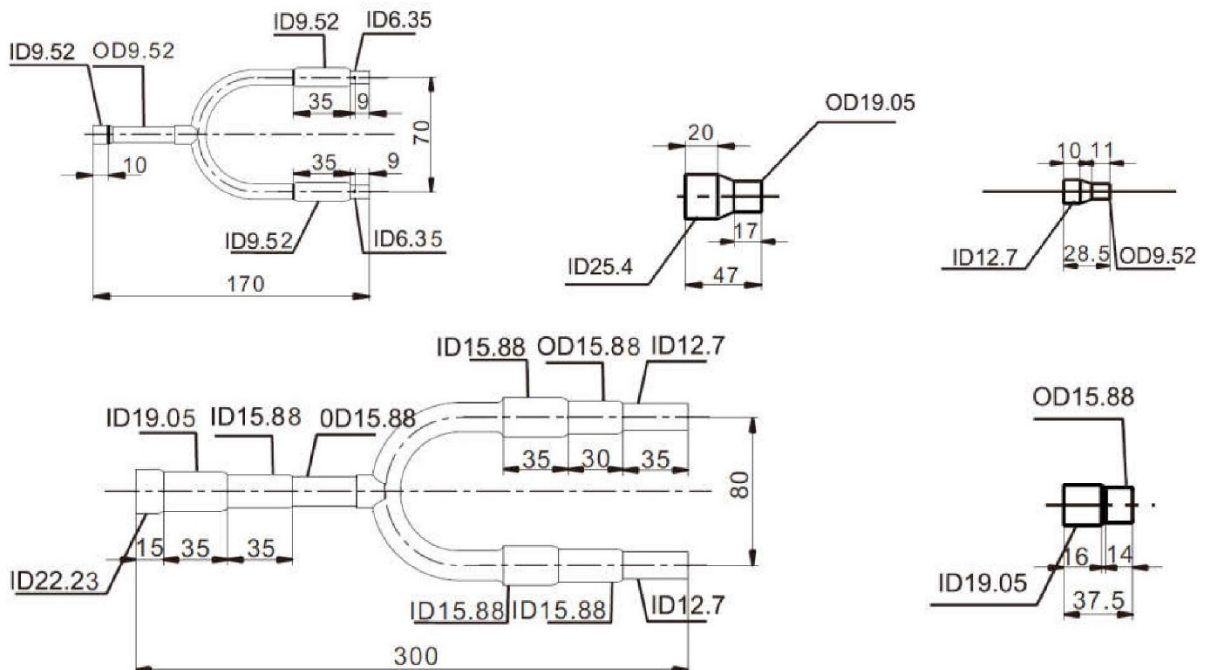

Installation of Refrigerant Piping

TBP4033TA

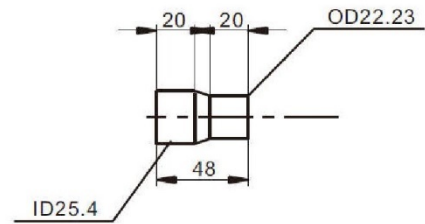
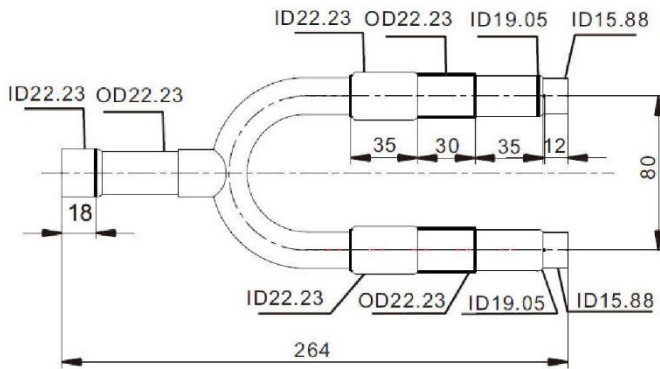
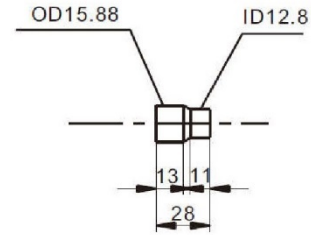
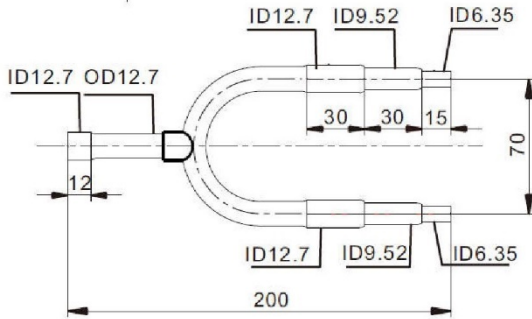

TBP4072TA

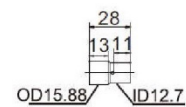
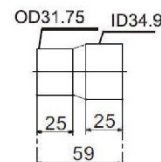
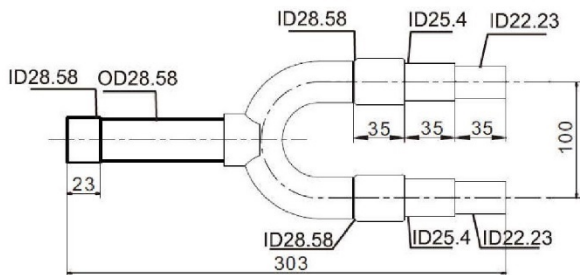
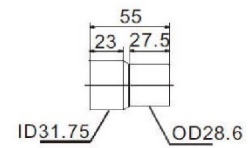
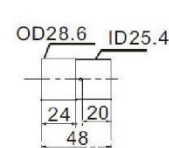
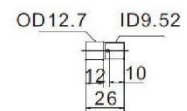
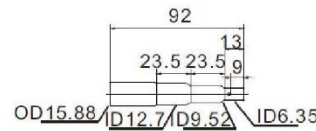
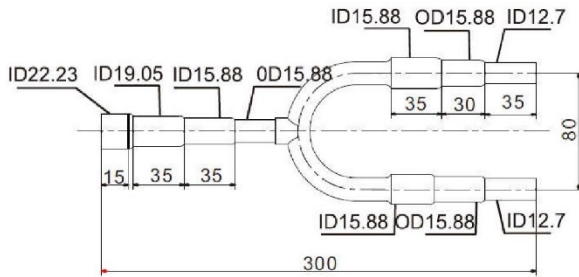

Installation of Refrigerant piping

TBP4073TA

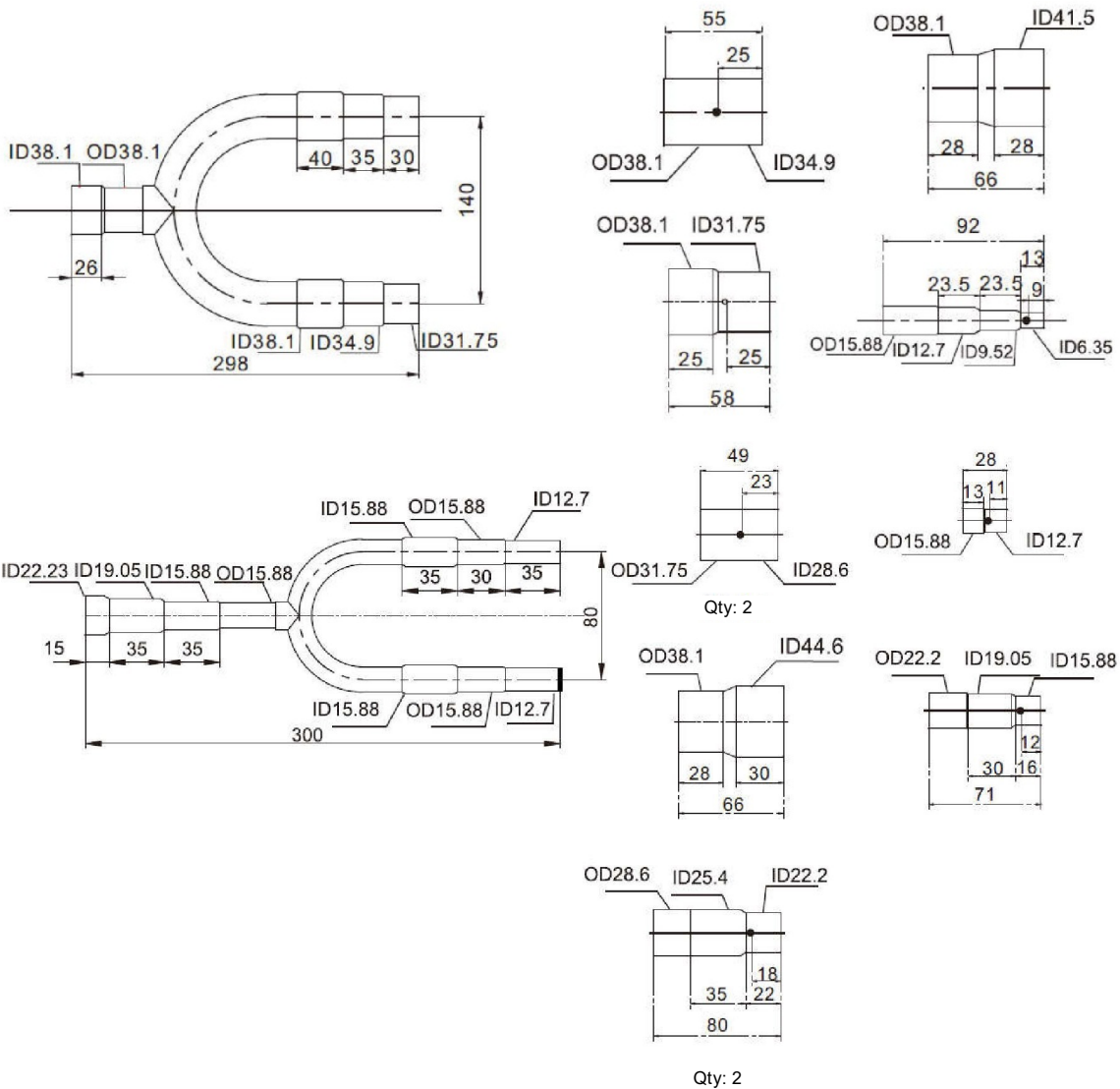

TBP4090TA

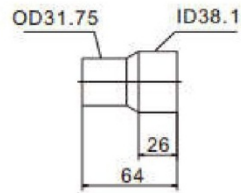
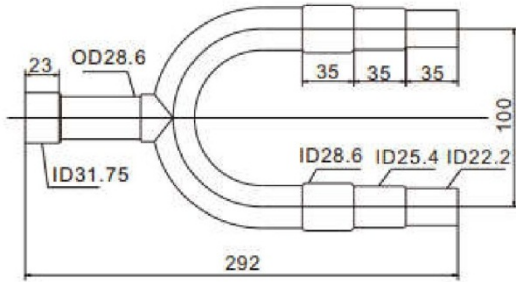
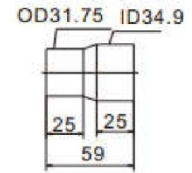
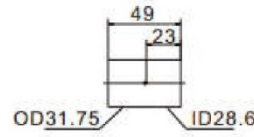
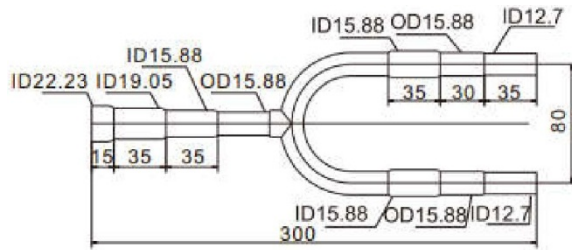

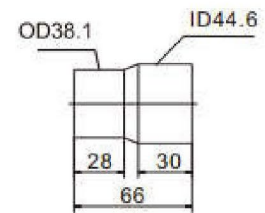
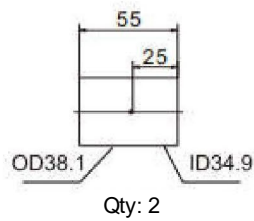
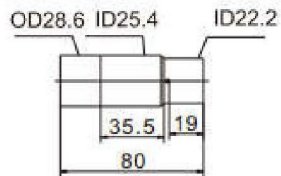
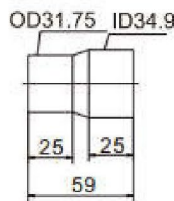
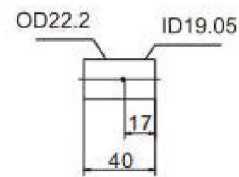
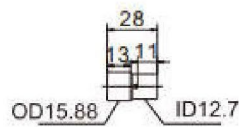
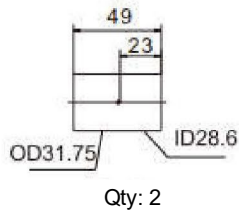
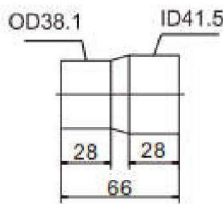
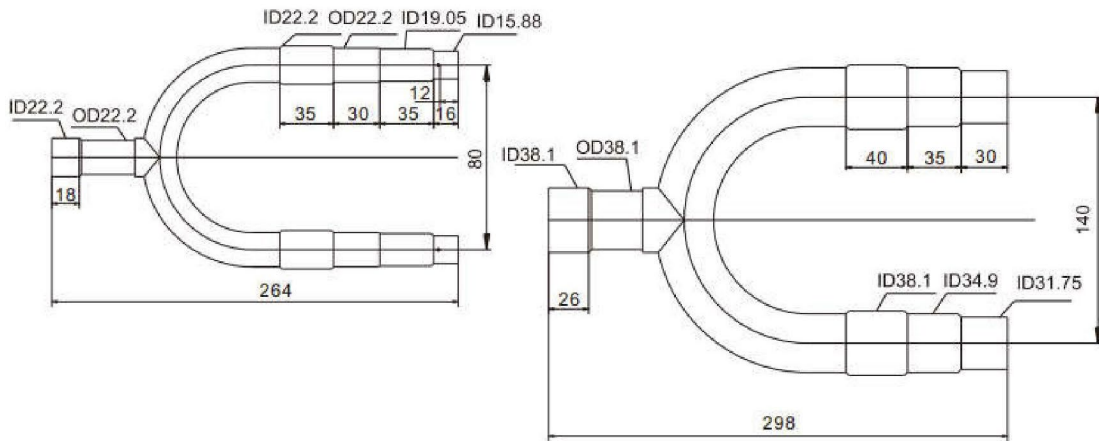
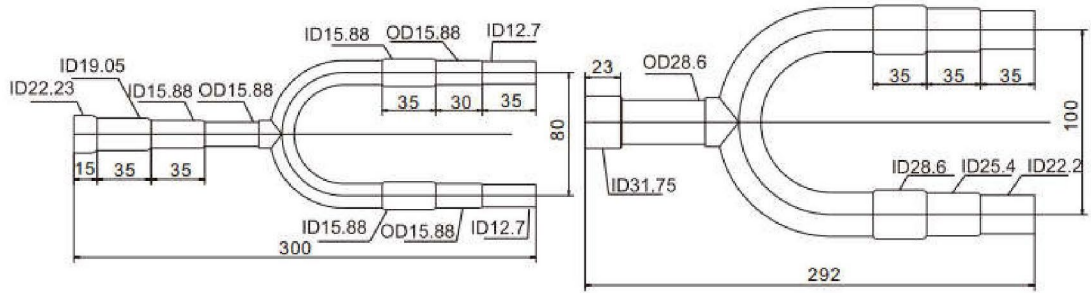
TBP4135TA

Installation of Refrigerant Piping

Refrigerant piping length

Capacity combination

$$50\% \leq \frac{\sum \text{Rated cooling capacity of IDU}}{\text{Rated cooling capacity of ODU}} \leq 130\%$$

Remarks: It is recommended that the above value shall not be greater than 100% when selecting models. For scenarios with lower simultaneous usage coefficient, the above value may exceed 100%.

Unit capacity		Single module	Double module	Triple module
Maximum equivalent piping length		≤ 400 m	≤ 600 m	≤ 1000 m
Level difference	Level difference between IDU and ODU	H1 ≤ 50 m (when the ODU is at the upper position)		
		H1 ≤ 40 m (when the ODU is at the lower position)		
	Level difference among IDUs	H2 ≤ 30 m		

Note (1): Equivalent length is the converted length after taking into account of pressure losses at elbows.

Equivalent length = actual pipe length + number of elbows x equivalent length of each elbow

Equivalent length of every place of branch pipe is 0.5 m, and please refer to the following table for equivalent length of elbows.

Pipe diameter	Equivalent length
	Elbow (m)
Φ9.52	0.18
Φ12.7	0.2
Φ15.88	0.25
Φ19.05	0.35
Φ22.23	0.4
Φ25.4	0.45
Φ28.6	0.5
Φ31.8	0.55
Φ34.9	0.6
Φ38.1	0.65
Φ41.3	0.7

Precautions when breaking through the knockout

- Do not damage the unit shell when trying to break through the knockout.
- Smooth the burrs around the hole and apply anti-rust paint after opening the knockout with a mallet or other tools.
- When passing the wire through knockout, put grommet in the hole or wrap wires with adhesive tape for protection.

Air Tightness Test, Vacuuming and Supplementing Refrigerant

For TIMS units, vacuum pump, pressure gauge, compound pressure gauge and charging hose used for R410A refrigerant are different from those used for R22 refrigerant. Make sure to use R410A dedicated tools.

Air tightness test

Notes:

- After piping work is completed, make sure to do air tightness test for IDU and piping.
- Do not use flammable gas or air (oxygen) as pressurized gas, otherwise fire or explosion may be caused; use nitrogen only.

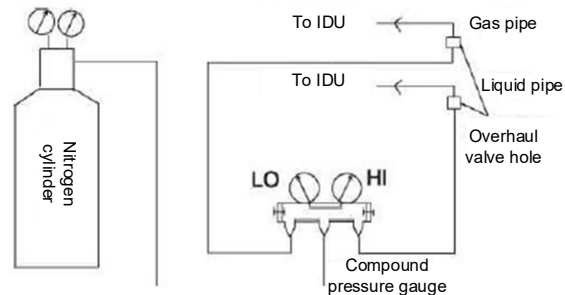

Steps:

- (1) Use a vacuum pump to discharge air out of the system from the spool of liquid-side check valve. Hold gauge pressure at -1 kgf/cm^2 for one hour. If pressure increases, the system may contain water or leak; otherwise, perform the next step.
- (2) Close the vacuum pump and increase pressure by 0.3 MPa from the spool of air-/liquid-side check valve and hold it for three minutes. Check whether there are major leakage points.
- (3) Continue to increase pressure to 1.5 MPa for three minutes, and check whether there are minor leakage points.
- (4) Continue to increase pressure to 4 MPa for 24 hours (consider the impact from the ambient temperature), and check whether are micro leakage points.



Notes:

- Use nitrogen in air tightness test instead of oxygen, flammable and toxic gas, or water.
- Use a pressure gauge dedicated for R410A with a range above than 4.5 MPa.
- Connect high pressure pipe and low pressure pipe and increase pressure for them at the same time without connecting to ODU.
- After passing the air tightness test, the unit is required to lower the levels of pressure to 0.2 to 0.3 MPa and be stored at a fixed pressure.

Vacuumizing:

- Use the vacuum pump with over 4 L/S gas displacement. The vacuum pump ensures the vacuum degree of the system below 755 mmHg.
- Use the vacuum pump equipped with an electronic single way valve to prevent lubricating oil from entering the refrigerant system against the current.
- Vacuumize the gas pipe and liquid pipe at the same time. Before

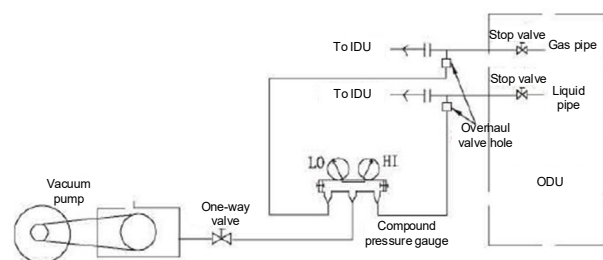

vacuumizing, verify that gas and liquid side check valves of ODU are closed.

- Use tools dedicated to R410A, such as pressure gauges and filling pipes.

Air Tightness Test, Vacuuming and Supplementing Refrigerant

Supplementing refrigerant

Principles:

Before delivery, the ODUs have been charged with a certain amount of refrigerant, but which cannot meet the needs of extended pipes. So refrigerant has to be added according to the actual length of refrigerant piping at installation site.

Steps:

- Close compound pressure gauge, replace vacuum pump with charge tank connected with charging pipe. Make sure the air is drained completely, and connect the joints of charge tanks and put the tank mouth down on the platform scale.
- Set the quantity to be filled at the electronic scale, and successively open the valve of charge tank and valve of compound pressure gauge to fill the system with refrigerant. When reaching the limits, immediately close valve of charge tank and disconnect connection pipes.

Notes:

- For refrigerant tank with siphon: the tank needs not to be put upside down because the siphon can reach the tank bottom.
- If using R410A charge tank without siphon, make sure the tank is put upside down in the charge process, which is shown as below:

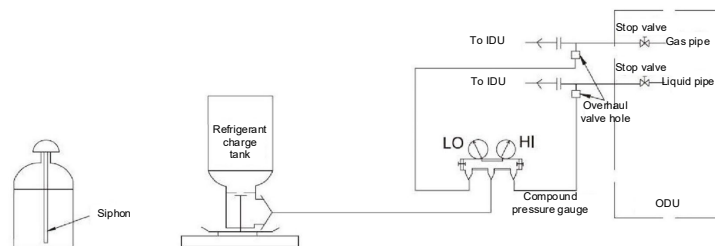

Calculation of the refrigerant amount to be supplemented (R410A):

Liquid pipe diameter (mm)	6.35	9.52	12.7	15.88	19.05	22.23
Supplemented refrigerant quantity (g/m)	22	57	110	170	260	360

Supplemented refrigerant amount = Σ Liquid pipe length at various diameters x
Supplemented refrigerant amount per meter

Notes:

1. For single modular units, the maximum refrigerant amount (unit + total supplemented amount) should not be greater than 52 kg. Otherwise, the units fail to run reliably.
2. For multi-modular units, when the calculated added refrigerant is over 40 kg, the actually added refrigerant volume should be the 80% of the calculated value or 40 kg (whichever is greater).

For example, if the calculated value of the additional refrigerant volume is 45 kg, $45 \times 0.8 = 36$ kg, and the actually added refrigerant volume is 40 kg.

If the calculated amount of the supplemented refrigerant is 60 kg and $60 \times 0.8 = 48$ kg, the actually refrigerant amount is 48 kg.

Electric Control Installation

Wiring cautions

Cautions for power wiring

- Use copper wire as power wire and do not make it too tight.
- The IDU and ODU use different circuits: the ODU uses a three-phase power supply, while the IDU uses a single-phase power supply
- All the IDUs and ODUs of the same system must be supplied with power simultaneously.
- The distribution box shall be provided with a set of electric leakage protection device and air switch for each module.
- Make sure all the earth lines of the unit are connected to ground securely. Do not connect earth lines to lightning devices, telephone line, gas pipe or tap water pipe. Improper grounding may cause electrical shock or fire.

Cautions communication line wiring

- TICS independent/strong heat independent inverter VRF air conditioning unit has both high voltage (power) line and control (communications) line. Do not connect power line to the connecting terminal of communication cables!
- The total length of communication line is less than 1000 m.

The shielding layer of communication line must be connected to earth lines of each module and IDUs securely.

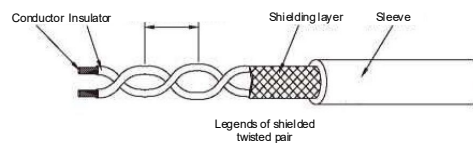

- Communication cable is well connected before being powered on. Do not remove the power plug with power on, lest the communication chips would be damaged.
- To prevent high voltage signal from disturbing control signal, shielded twisted pair must be used.

Try to select shielded twisted pair with dense shielding layers and smaller lay.

- Control signal has two polarities A and B, and different polarities cannot be connected, otherwise communication failures may be caused;

As shown in the following figure:

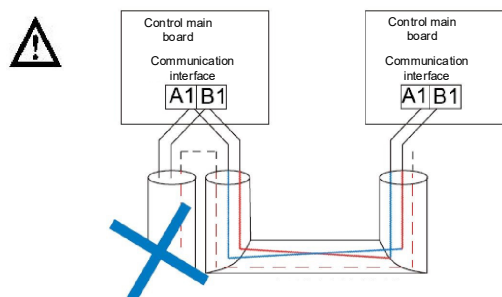

- When power line is parallel with communication line, they shall be covered by respective conduits and kept at some distance away.

Electric Control Installation

Wiring specifications

Notes:

- As wires need to be bent during installation process, it is recommended to use flexible wires, otherwise installation may fail.
- The parameters in the table below are corresponding to multiple strands of flexible copper wires. If other wires are selected, please refer to electrician's manual based on wiring current provided in the table.
- For safety purpose, do not carry out wiring work based on rated current, for the operating conditions may be varied with seasons.

Table of ODU wiring specification

1. Single module

ODU model	Power supply	Voltage range (V)	Wiring current (A)	General power cord	Length (m)	GND	Communication line
TIMS080-X/XS/XA/XC	3N/380V/50Hz	418/342	20	6 mm ²	≤ 20	6 mm ²	0.75-1.25 mm ² polyethylene shielded twisted pair
				10 mm ²	20-50	10 mm ²	
TIMS100-X/XS/XA/XC		418/342	25	6 mm ²	≤ 20	6 mm ²	
				10 mm ²	20-50	10 mm ²	
TIMS120-X/XS/XA/XC		418/342	32	6 mm ²	≤ 20	6 mm ²	
				10 mm ²	20~50	10 mm ²	
TIMS140-X/XS/XA/XC		418/342	40	10 mm ²	≤ 20	10 mm ²	
				16 mm ²	20~50	16 mm ²	
TIMS160-X/XS/XA/XC		418/342	40	10 mm ²	≤ 20	10 mm ²	
				16 mm ²	20 ~50	16 mm ²	
TIMS180-XA/XT		418/342	50	10 mm ²	≤ 20	10 mm ²	
				16 mm ²	20~50	16 mm ²	
TIMS180-X TIMS200-X/XA/XT		418/342	50	16 mm ²	≤ 20	16 mm ²	
				25 mm ²	20 to 50	25 mm ²	
TIMS220-X/XA		418/342	63	16 mm ²	≤ 20	16 mm ²	
				25 mm ²	20~50	25 mm ²	
TIMS240-XA		418/342	63	16 mm ²	≤ 20	16 mm ²	
				25 mm ²	20~50	25 mm ²	
TIMS260-XA		418/342	80	25 mm ²	≤ 20	25 mm ²	
				35 mm ²	20-50	35 mm ²	
TIMS280-XA	418/342	80	25 mm ²	≤ 20	25 mm ²		
			35 mm ²	20~50	35 mm ²		
TIMS300-XA	418/342	80	25 mm ²	≤ 20	25 mm ²		
			35 mm ²	20~50	35 mm ²		
TIMS320-XA	418/342	80	25 mm ²	≤ 20	25 mm ²		
			35 mm ²	20-50	35 mm ²		
TIMS340-XA	418/342	80	25 mm ²	≤ 20	25 mm ²		
			35 mm ²	20~50	35 mm ²		

2. Multiple modules (X series)

ODU model	Modular	Power supply	Voltage range	Wiring current	General power cord	Length	Earth line	Communication line
TIMS240-X	TIMS100	3N/380V/50Hz	418/342	20	6 mm ²	≤ 20	6 mm ²	0.75 to 1.25 mm ² polyethylene shielded twisted pair
	10 mm ²				20~50	10 mm ²		
TIMS140	40		10 mm ²	≤ 20	10 mm ²			
			16 mm ²	20~50	16 mm ²			
TIMS260-X	TIMS100		418/342	20	6 mm ²	≤ 20	6 mm ²	
	10 mm ²				20~50	10 mm ²		
TIMS160	40		10 mm ²	≤ 20	10 mm ²			
			16 mm ²	20~50	16 mm ²			
TIMS280-X	TIMS140		418/342	40	10 mm ²	≤ 20	10 mm ²	
	16 mm ²				20~50	16 mm ²		
TIMS140	40		10 mm ²	≤ 20	10 mm ²			
			16 mm ²	20~50	16 mm ²			
TIMS300-X	TIMS140		418/342	40	10 mm ²	≤ 20	10 mm ²	
	16 mm ²				20~50	16 mm ²		
TIMS160	40		10 mm ²	≤ 20	10 mm ²			
			16 mm ²	20~50	16 mm ²			
TIMS320-X	TIMS160		418/342	40	10 mm ²	≤ 20	10 mm ²	
	16 mm ²				20~50	16 mm ²		
TIMS160	40		10 mm ²	≤ 20	10 mm ²			
			16 mm ²	20~50	16 mm ²			
TIMS340-X	TIMS140	418/342	40	10 mm ²	≤ 20	10 mm ²		
	16 mm ²			20~50	16 mm ²			
TIMS200	50	16 mm ²	≤ 20	16 mm ²				
		25 mm ²	20~50	25 mm ²				
TIMS360-X	TIMS140	418/342	40	10 mm ²	≤ 20	10 mm ²		
	16 mm ²			20~50	16 mm ²			
TIMS220	63	16 mm ²	≤ 20	16 mm ²				
		25 mm ²	20~50	25 mm ²				
TIMS380-X	TIMS160	418/342	40	10 mm ²	≤ 20	10 mm ²		
	16 mm ²			20~50	16 mm ²			
TIMS220	63	16 mm ²	≤ 20	16 mm ²				
		25 mm ²	20~50	25 mm ²				
TIMS400-X	TIMS200	418/342	50	16 mm ²	≤ 20	16 mm ²		
	25 mm ²			20~50	25 mm ²			
TIMS200	50	16 mm ²	≤ 20	16 mm ²				
		25 mm ²	20~50	25 mm ²				
TIMS420-X	TIMS200	418/342	50	16 mm ²	≤ 20	16 mm ²		
	25 mm ²			20~50	25 mm ²			
TIMS220	63	16 mm ²	≤ 20	16 mm ²				
		25 mm ²	20~50	25 mm ²				

2. Multiple modules (X series)

ODU model	Modular	Power supply	Voltage range	Wiring current	General power cord	Length	Earth line	Communication line
TIMS440-X	TIMS220	3N/380V/50Hz	418/342	63	16 mm ²	≤ 20	16 mm ²	0.75 to 1.25 mm ² polyethylene shielded twisted pair
					25 mm ²	20~50	25 mm ²	
	63			16 mm ²	≤ 20	16 mm ²		
				25 mm ²	20~50	25 mm ²		
TIMS460-X	TIMS140		418/342	40	10 mm ²	≤ 20	10 mm ²	
					16 mm ²	20~50	16 mm ²	
	TIMS160			40	10 mm ²	≤ 20	10 mm ²	
					16 mm ²	20~50	16 mm ²	
	TIMS160			40	10 mm ²	≤ 20	10 mm ²	
					16 mm ²	20~50	16 mm ²	
TIMS480-X	TIMS160		418/342	40	10 mm ²	≤ 20	10 mm ²	
					16 mm ²	20~50	16 mm ²	
	TIMS160	40		10 mm ²	≤ 20	10 mm ²		
				16 mm ²	20~50	16 mm ²		
	TIMS160	40		10 mm ²	≤ 20	10 mm ²		
				16 mm ²	20~50	16 mm ²		
TIMS500-X	TIMS140	418/342	40	10 mm ²	≤ 20	10 mm ²		
				16 mm ²	20~50	16 mm ²		
	TIMS160		40	10 mm ²	≤ 20	10 mm ²		
				16 mm ²	20~50	16 mm ²		
	TIMS200		50	16 mm ²	≤ 20	16 mm ²		
				25 mm ²	20~50	25 mm ²		
TIMS520-X	TIMS160	418/342	40	10 mm ²	≤ 20	10 mm ²		
				16 mm ²	20~50	16 mm ²		
	TIMS160		40	10 mm ²	≤ 20	10 mm ²		
				16 mm ²	20~50	16 mm ²		
	TIMS200		50	16 mm ²	≤ 20	16 mm ²		
				25 mm ²	20~50	25 mm ²		
TIMS540-X	TIMS160	418/342	40	10 mm ²	≤ 20	10 mm ²		
				16 mm ²	20~50	16 mm ²		
	TIMS160		40	10 mm ²	≤ 20	10 mm ²		
				16 mm ²	20~50	16 mm ²		
	TIMS220		63	16 mm ²	≤ 20	16 mm ²		
				25 mm ²	20~50	25 mm ²		
TIMS560-X	TIMS140	418/342	40	10 mm ²	≤ 20	10 mm ²		
				16 mm ²	20~50	16 mm ²		
	TIMS200		50	16 mm ²	≤ 20	16 mm ²		
				25 mm ²	20~50	25 mm ²		
	TIMS220		63	16 mm ²	≤ 20	16 mm ²		
				25 mm ²	20~50	25 mm ²		

2. Multiple modules (X series)

ODU model	Modular	Power supply	Voltage range	Wiring current	General power cord	Length	Earth line	Communication line
TIMS580-X	TIMS140	3N/380V/50Hz	418/342	40	10 mm ²	≤ 20	10 mm ²	0.75 to 1.25 mm ² polyethylene shielded twisted pair
					16 mm ²	20~50	16 mm ²	
	TIMS220			63	16 mm ²	≤ 20	16 mm ²	
					25 mm ²	20~50	25 mm ²	
	TIMS220			63	16 mm ²	≤ 20	16 mm ²	
					25 mm ²	20~50	25 mm ²	
TIMS600-X	TIMS160		418/342	40	10 mm ²	≤ 20	10 mm ²	
					16 mm ²	20~50	16 mm ²	
	TIMS220			63	16 mm ²	≤ 20	16 mm ²	
					25 mm ²	20~50	25 mm ²	
	TIMS220			63	16 mm ²	≤ 20	16 mm ²	
					25 mm ²	20~50	25 mm ²	
TIMS620-X	TIMS200	418/342	50	16 mm ²	≤ 20	16 mm ²		
				25 mm ²	20~50	25 mm ²		
	TIMS200		50	16 mm ²	≤ 20	16 mm ²		
				25 mm ²	20~50	25 mm ²		
	TIMS220		63	16 mm ²	≤ 20	16 mm ²		
				25 mm ²	20~50	25 mm ²		
TIMS640-X	TIMS200	418/342	50	16 mm ²	≤ 20	16 mm ²		
				25 mm ²	20~50	25 mm ²		
	TIMS220		63	16 mm ²	≤ 20	16 mm ²		
				25 mm ²	20~50	25 mm ²		
	TIMS220		63	16 mm ²	≤ 20	16 mm ²		
				25 mm ²	20~50	25 mm ²		
TIMS660-X	TIMS220	418/342	63	16 mm ²	≤ 20	16 mm ²		
				25 mm ²	20~50	25 mm ²		
	TIMS220		63	16 mm ²	≤ 20	16 mm ²		
				25 mm ²	20~50	25 mm ²		
	TIMS220		63	16 mm ²	≤ 20	16 mm ²		
				25 mm ²	20~50	25 mm ²		

2. Multiple modules (XA series)

ODU model	Modular	Power supply	Voltage range	Wiring current	General power cord	Length	Earth line	Communication line
TIMS340-XA	TIMS180	3N/380V/50Hz	418/342	50	10 mm ²	≤ 20	10 mm ²	0.75 to 1.25 mm ² polyethylene shielded twisted pair
					16 mm ²	20~50	16 mm ²	
	TIMS160			40	10 mm ²	≤ 20	10 mm ²	
					16 mm ²	20~50	16 mm ²	
TIMS360-XA	TIMS180		418/342	50	10 mm ²	≤ 20	10 mm ²	
					16 mm ²	20~50	16 mm ²	
	TIMS180			50	10 mm ²	≤ 20	10 mm ²	
					16 mm ²	20~50	16 mm ²	
TIMS380-XA	TIMS200		418/342	50	16 mm ²	≤ 20	16 mm ²	
	TIMS180				25 mm ²	20~50	25 mm ²	
				TIMS180	50	10 mm ²	≤ 20	
	16 mm ²					20~50	16 mm ²	
TIMS400-XA	TIMS200		418/342	50	16 mm ²	≤ 20	16 mm ²	
	TIMS200				25 mm ²	20~50	25 mm ²	
				TIMS200	50	16 mm ²	≤ 20	
	25 mm ²					20~50	25 mm ²	
TIMS420-XA	TIMS220	418/342	63	16 mm ²	≤ 20	16 mm ²		
	TIMS200			25 mm ²	20~50	25 mm ²		
			TIMS200	50	16 mm ²	≤ 20	16 mm ²	
	25 mm ²				20~50	25 mm ²		
TIMS440-XA	TIMS220	418/342	63	16 mm ²	≤ 20	16 mm ²		
	TIMS220			25 mm ²	20~50	25 mm ²		
			TIMS220	63	16 mm ²	≤ 20	16 mm ²	
	25 mm ²				20~50	25 mm ²		
TIMS460-XA	TIMS240	418/342	63	16 mm ²	≤ 20	16 mm ²		
	TIMS220			25 mm ²	20~50	25 mm ²		
			TIMS220	63	16 mm ²	≤ 20	16 mm ²	
	25 mm ²				20~50	25 mm ²		
TIMS480-XA	TIMS240	418/342	63	16 mm ²	≤ 20	16 mm ²		
	TIMS240			25 mm ²	20~50	25 mm ²		
			TIMS240	63	16 mm ²	≤ 20	16 mm ²	
	25 mm ²				20~50	25 mm ²		
TIMS500-XA	TIMS280	418/342	80	25 mm ²	≤ 20	25 mm ²		
	TIMS220			35 mm ²	20~50	35 mm ²		
			TIMS220	63	16 mm ²	≤ 20	16 mm ²	
	25 mm ²				20~50	25 mm ²		
TIMS520-XA	TIMS280	418/342	80	25 mm ²	≤ 20	25 mm ²		
	TIMS240			35 mm ²	20~50	35 mm ²		
			TIMS240	80	16 mm ²	≤ 20	16 mm ²	
	25 mm ²				20~50	25 mm ²		

2. Multiple modules (XA series)

ODU model	Modular	Power supply	Voltage range	Wiring current	General power cord	Length	Earth line	Communication line	
TIMS540-XA	TIMS280	3N/38 0V/50 Hz	418/342	80	25mm ²	≤20	25mm ²	0.75 to 1.25 mm ² polyethylene shielded twisted pair	
	35mm ²				20~50	35mm ²			
TIMS260	TIMS280		418/342	80	80	25mm ²	≤20		25mm ²
	35mm ²					20~50	35mm ²		
TIMS560-XA	TIMS280		418/342	80	80	25mm ²	≤20		25mm ²
	35mm ²					20~50	35mm ²		
TIMS280	TIMS280		418/342	80	80	25mm ²	≤20		25mm ²
	35mm ²					20~50	35mm ²		
TIMS580-XA	TIMS300		418/342	80	80	25mm ²	≤20		25mm ²
	35mm ²					20~50	35mm ²		
TIMS280	TIMS280		418/342	80	80	25mm ²	≤20		25mm ²
	35mm ²					20~50	35mm ²		
TIMS600-XA	TIMS300		418/342	80	80	25mm ²	≤20		25mm ²
	35mm ²					20~50	35mm ²		
TIMS300	TIMS300		418/342	80	80	25mm ²	≤20		25mm ²
	35mm ²					20~50	35mm ²		
TIMS620-XA	TIMS320		418/342	80	80	25mm ²	≤20		25mm ²
	35mm ²					20~50	35mm ²		
TIMS300	TIMS300		418/342	80	80	25mm ²	≤20		25mm ²
	35mm ²					20~50	35mm ²		
TIMS640-XA	TIMS320		418/342	80	80	25mm ²	≤20		25mm ²
	35mm ²					20~50	35mm ²		
TIMS320	TIMS320		418/342	80	80	25mm ²	≤20		25mm ²
	35mm ²					20~50	35mm ²		
TIMS660-XA	TIMS340	418/342	80	80	25mm ²	≤20	25mm ²		
	35mm ²				20~50	35mm ²			
TIMS320	TIMS320	418/342	80	80	25mm ²	≤20	25mm ²		
	35mm ²				20~50	35mm ²			
TIMS680-XA	TIMS340	418/342	80	80	25mm ²	≤20	25mm ²		
	35mm ²				20~50	35mm ²			
TIMS340	TIMS340	418/342	80	80	25mm ²	≤20	25mm ²		
	35mm ²				20~50	35mm ²			
TIMS700-XA	TIMS240	418/342	63	63	16mm ²	≤20	16mm ²		
	25mm ²				20~50	25mm ²			
TIMS240	TIMS240	418/342	63	63	16mm ²	≤20	16mm ²		
	25mm ²				20~50	25mm ²			
TIMS220	TIMS220	418/342	63	63	16mm ²	≤20	16mm ²		
	25mm ²				20~50	25mm ²			

ODU model	Modular	Power supply	Voltage range	Wiring current	General power cord	Length	Earth line	Communication line
TIMS720-XA	TIMS240	3N/38 0V/50 Hz	418/342	63	16mm ²	≤20	16mm ²	0.75 to 1.25 mm ² polyethylene shielded twisted pair
					25mm ²	20~50	25mm ²	
	TIMS240			63	16mm ²	≤20	16mm ²	
					25mm ²	20~50	25mm ²	
	TIMS240			63	16mm ²	≤20	16mm ²	
					25mm ²	20~50	25mm ²	
TIMS740-XA	TIMS260		418/342	80	25mm ²	≤20	25mm ²	
	35mm ²				20~50	35mm ²		
	TIMS240			63	16mm ²	≤20	16mm ²	
					25mm ²	20~50	25mm ²	
	TIMS240			63	16mm ²	≤20	16mm ²	
					25mm ²	20~50	25mm ²	
TIMS760-XA	TIMS260	418/342	80	25mm ²	≤20	25mm ²		
	35mm ²			20~50	35mm ²			
	TIMS260		80	25mm ²	≤20	25mm ²		
				35mm ²	20~50	35mm ²		
	TIMS240		63	25mm ²	≤20	25mm ²		
				35mm ²	20~50	35mm ²		
TIMS780-XA	TIMS260	418/342	80	25mm ²	≤20	25mm ²		
	35mm ²			20~50	35mm ²			
	TIMS260		80	25mm ²	≤20	25mm ²		
				35mm ²	20~50	35mm ²		
	TIMS260		80	25mm ²	≤20	25mm ²		
				35mm ²	20~50	35mm ²		
TIMS800-XA	TIMS280	418/342	80	25mm ²	≤20	25mm ²		
	35mm ²			20~50	35mm ²			
	TIMS260		80	25mm ²	≤20	25mm ²		
				35mm ²	20~50	35mm ²		
	TIMS260		80	25mm ²	≤20	25mm ²		
				35mm ²	20~50	35mm ²		
TIMS820-XA	TIMS280	418/342	80	25mm ²	≤20	25mm ²		
	35mm ²			20~50	35mm ²			
	TIMS280		80	25mm ²	≤20	25mm ²		
				35mm ²	20~50	35mm ²		
	TIMS260		80	25mm ²	≤20	25mm ²		
				35mm ²	20~50	35mm ²		

ODU model	Modular	Power	Voltage	Wiring	General	Length	Earth line	Communica
-----------	---------	-------	---------	--------	---------	--------	------------	-----------

		supply	range	current	power cord		tion line
TIMS840-XA	TIMS280	3N/38 0V/50 Hz	418/342	80	25mm ²	≤20	25mm ²
					35mm ²	20~50	35mm ²
	TIMS280			80	25mm ²	≤20	25mm ²
					35mm ²	20~50	35mm ²
	TIMS280			80	25mm ²	≤20	25mm ²
					35mm ²	20~50	35mm ²
TIMS860-XA	TIMS300		418/342	80	25mm ²	≤20	25mm ²
	35mm ²				20~50	35mm ²	
	TIMS280			80	25mm ²	≤20	25mm ²
					35mm ²	20~50	35mm ²
	TIMS280			80	25mm ²	≤20	25mm ²
					35mm ²	20~50	35mm ²
TIMS880-XA	TIMS300	418/342	80	25mm ²	≤20	25mm ²	
	35mm ²			20~50	35mm ²		
	TIMS300		80	25mm ²	≤20	25mm ²	
				35mm ²	20~50	35mm ²	
	TIMS280		80	25mm ²	≤20	25mm ²	
				35mm ²	20~50	35mm ²	
TIMS900-XA	TIMS300	418/342	80	25mm ²	≤20	25mm ²	
	35mm ²			20~50	35mm ²		
	TIMS300		80	25mm ²	≤20	25mm ²	
				35mm ²	20~50	35mm ²	
	TIMS300		80	25mm ²	≤20	25mm ²	
				35mm ²	20~50	35mm ²	
TIMS920-XA	TIMS320	418/342	80	25mm ²	≤20	25mm ²	
	35mm ²			20~50	35mm ²		
	TIMS300		80	25mm ²	≤20	25mm ²	
				35mm ²	20~50	35mm ²	
	TIMS300		80	25mm ²	≤20	25mm ²	
				35mm ²	20~50	35mm ²	
TIMS940-XA	TIMS320	418/342	80	25mm ²	≤20	25mm ²	
	35mm ²			20~50	35mm ²		
	TIMS320		80	25mm ²	≤20	25mm ²	
				35mm ²	20~50	35mm ²	
	TIMS300		80	25mm ²	≤20	25mm ²	
				35mm ²	20~50	35mm ²	

0.75 to 1.25
mm²
polyethylene
shielded
twisted pair

ODU model	Modular	Power supply	Voltage range	Wiring current	General power cord	Length	Earth line	Communication line
TIMS960-XA	TIMS320	3N/380 V/50Hz	418/342	80	25mm ²	≤20	25mm ²	0.75 to 1.25 mm ² polyethylene shielded twisted pair
					35mm ²	20~50	35mm ²	
	TIMS320			80	25mm ²	≤20	25mm ²	
					35mm ²	20~50	35mm ²	
	TIMS320			80	25mm ²	≤20	25mm ²	
					35mm ²	20~50	35mm ²	
TIMS980-XA	TIMS340		418/342	80	25mm ²	≤20	25mm ²	
	35mm ²				20~50	35mm ²		
	TIMS320			80	25mm ²	≤20	25mm ²	
					35mm ²	20~50	35mm ²	
	TIMS320			80	25mm ²	≤20	25mm ²	
					35mm ²	20~50	35mm ²	
TIMS1000-XA	TIMS340	418/342	80	25mm ²	≤20	25mm ²		
	35mm ²			20~50	35mm ²			
	TIMS340		80	25mm ²	≤20	25mm ²		
				35mm ²	20~50	35mm ²		
	TIMS320		80	25mm ²	≤20	25mm ²		
				35mm ²	20~50	35mm ²		
TIMS1020-XA	TIMS340	418/342	80	25mm ²	≤20	25mm ²		
	35mm ²			20~50	35mm ²			
	TIMS340		80	25mm ²	≤20	25mm ²		
				35mm ²	20~50	35mm ²		
	TIMS340		80	25mm ²	≤20	25mm ²		
				35mm ²	20~50	35mm ²		

2. Multiple modules (XT series)

ODU model	Modular	Power supply	Voltage range	Wiring current	General power cord	Length	Earth line	Communication line		
TIMS220-XT	TIMS100	3N/380V/50Hz	418/342	20	6 mm ²	≤ 20	6 mm ²	0.75~1.25 mm ² polyethylene shielded twisted pair		
	10 mm ²				20~50	10 mm ²				
TIMS120	TIMS120		32	418/342	32	6 mm ²	≤ 20		6 mm ²	
						10 mm ²	20~50		10 mm ²	
TIMS240-XT	TIMS120		418/342	32	32	6 mm ²	≤ 20		6 mm ²	
	10 mm ²					20~50	10 mm ²			
TIMS120	TIMS120			32	32	6 mm ²	≤ 20		6 mm ²	
						10 mm ²	20~50		10 mm ²	
TIMS260-XT	TIMS120		418/342	32	32	6 mm ²	≤ 20		6 mm ²	
	10 mm ²					20~50	10 mm ²			
TIMS140	TIMS140			40	40	10 mm ²	≤ 20		10 mm ²	
						16 mm ²	20~50		16 mm ²	
TIMS280-XT	TIMS140			418/342	40	40	10 mm ²		≤ 20	10 mm ²
	16 mm ²						20~50		16 mm ²	
TIMS140	TIMS140		40		40	10 mm ²	≤ 20		10 mm ²	
						16 mm ²	20~50		16 mm ²	
TIMS300-XT	TIMS140		418/342	40	40	10 mm ²	≤ 20		10 mm ²	
	16 mm ²					20~50	16 mm ²			
TIMS160	TIMS160			40	40	10 mm ²	≤ 20		10 mm ²	
						16 mm ²	20~50		16 mm ²	
TIMS320-XT	TIMS160	418/342	40	40	10 mm ²	≤ 20	10 mm ²			
	16 mm ²				20~50	16 mm ²				
TIMS160	TIMS160		40	40	10 mm ²	≤ 20	10 mm ²			
					16 mm ²	20~50	16 mm ²			
TIMS340-XT	TIMS160	418/342	40	40	10 mm ²	≤ 20	10 mm ²			
	16 mm ²				20~50	16 mm ²				
TIMS180	TIMS180		50	50	10 mm ²	≤ 20	10 mm ²			
					16 mm ²	20~50	16 mm ²			
TIMS360-XT	TIMS180	418/342	50	50	10 mm ²	≤ 20	10 mm ²			
	16 mm ²				20~50	16 mm ²				
TIMS180	TIMS180		50	50	10 mm ²	≤ 20	10 mm ²			
					16 mm ²	20~50	16 mm ²			
TIMS380-XT	TIMS180	418/342	50	50	10 mm ²	≤ 20	10 mm ²			
	16 mm ²				20~50	16 mm ²				
TIMS200	TIMS200		50	50	16 mm ²	≤ 20	16 mm ²			
					25 mm ²	20~50	25 mm ²			
TIMS400-XT	TIMS200	418/342	50	50	16 mm ²	≤ 20	16 mm ²			
	25 mm ²				20~50	25 mm ²				
TIMS200	TIMS200		50	50	16 mm ²	≤ 20	16 mm ²			
					25 mm ²	20~50	25 mm ²			

ODU model	Modular	Power supply	Voltage range	Wiring current	General power cord	Length	Earth line	Communication line	
TIMS180-XC	TIMS080	3N/380V/50Hz	418/342	20	6 mm ²	≤ 20	6 mm ²	0.75 to 1.25 mm ² polyethylene shielded twisted pair	
	10 mm ²				20~50	10 mm ²			
TIMS100	TIMS100		418/342	25	6 mm ²	≤ 20	6 mm ²		
	10 mm ²				20~50	10 mm ²			
TIMS200-XC	TIMS100		418/342	20	6 mm ²	≤ 20	6 mm ²		
					10 mm ²	20~50	10 mm ²		
	TIMS100			20	6 mm ²	≤ 20	6 mm ²		
					10 mm ²	20~50	10 mm ²		
TIMS220-XC	TIMS100		418/342	20	6 mm ²	≤ 20	6 mm ²		
	TIMS120				10 mm ²	20~50	10 mm ²		
TIMS240-XC	TIMS120		418/342	32	6 mm ²	≤ 20	6 mm ²		
	TIMS120				10 mm ²	20~50	10 mm ²		
TIMS260-XC	TIMS120			418/342	32	6 mm ²	≤ 20		6 mm ²
	TIMS140					10 mm ²	20~50		10 mm ²
TIMS280-XC	TIMS140		418/342	40	10 mm ²	≤ 20	10 mm ²		
					16 mm ²	20~50	16 mm ²		
	TIMS140			40	10 mm ²	≤ 20	10 mm ²		
					16 mm ²	20~50	16 mm ²		
TIMS300-XC	TIMS140		418/342	40	10 mm ²	≤ 20	10 mm ²		
	TIMS160				16 mm ²	20~50	16 mm ²		
		10 mm ²			≤ 20	10 mm ²			
TIMS320-XC	TIMS160	418/342	40	16 mm ²	20~50	16 mm ²			
	TIMS160			10 mm ²	≤ 20	10 mm ²			
				16 mm ²	20~50	16 mm ²			
TIMS340-XC	TIMS100	418/342	20	6 mm ²	≤ 20	6 mm ²			
	10 mm ²			20~50	10 mm ²				
	TIMS120		32	6 mm ²	≤ 20	6 mm ²			
	TIMS120			10 mm ²	20~50	10 mm ²			
TIMS120	32	6 mm ²	≤ 20	6 mm ²					
		10 mm ²	20~50	10 mm ²					

ODU model	Modular	Power supply	Voltage range	Wiring current	General power cord	Length	Earth line	Communication line
TIMS360-XC	TIMS120	3N/380V/50Hz	418/342	32	6 mm ²	≤ 20	6 mm ²	0.75 to 1.25 mm ² polyethylene shielded twisted pair
	10 mm ²				20~50	10 mm ²		
	TIMS120			32	6 mm ²	≤ 20	6 mm ²	
10 mm ²	20~50		10 mm ²					
TIMS120	32		6 mm ²	≤ 20	6 mm ²			
10 mm ²			20~50	10 mm ²				
TIMS380-XC	TIMS140		418/342	40	10 mm ²	≤ 20	10 mm ²	
	16 mm ²				20~50	16 mm ²		
	TIMS120			32	6 mm ²	≤ 20	6 mm ²	
TIMS120	10 mm ²		20~50		10 mm ²			
TIMS400-XC	TIMS140		418/342	40	10 mm ²	≤ 20	10 mm ²	
	16 mm ²				20~50	16 mm ²		
	TIMS120			32	6 mm ²	≤ 20	6 mm ²	
10 mm ²	20~50		10 mm ²					
TIMS420-XC	TIMS140		418/342	40	10 mm ²	≤ 20	10 mm ²	
	16 mm ²				20~50	16 mm ²		
	TIMS140			40	10 mm ²	≤ 20	10 mm ²	
TIMS140	16 mm ²		20 to 50		16 mm ²			
TIMS440-XC	TIMS160		418/342	40	10 mm ²	≤ 20	10 mm ²	
	16 mm ²				20~50	16 mm ²		
	TIMS140			40	10 mm ²	≤ 20	10 mm ²	
TIMS140	16 mm ²		20~50		16 mm ²			
TIMS460-XC	TIMS160		418/342	40	10 mm ²	≤ 20	10 mm ²	
	16 mm ²				20~50	16 mm ²		
	TIMS140	40		10 mm ²	≤ 20	10 mm ²		
16 mm ²	20~50		16 mm ²					
TIMS480-XC	TIMS160	418/342	40	10 mm ²	≤ 20	10 mm ²		
	16 mm ²			20~50	16 mm ²			
	TIMS160		40	10 mm ²	≤ 20	10 mm ²		
TIMS160	16 mm ²	20~50		16 mm ²				

Electrical wiring

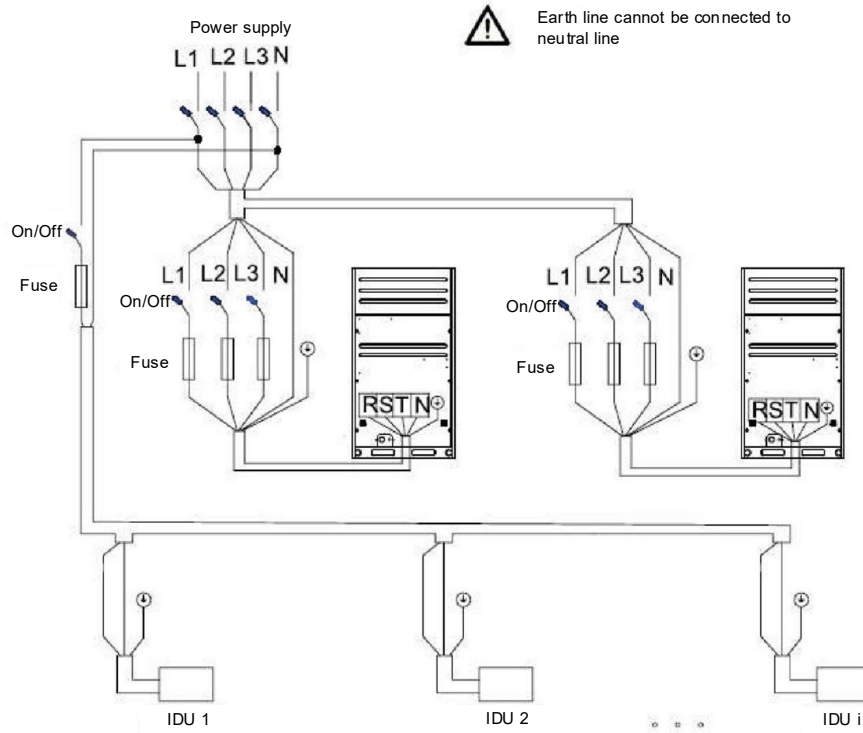

Communication wiring

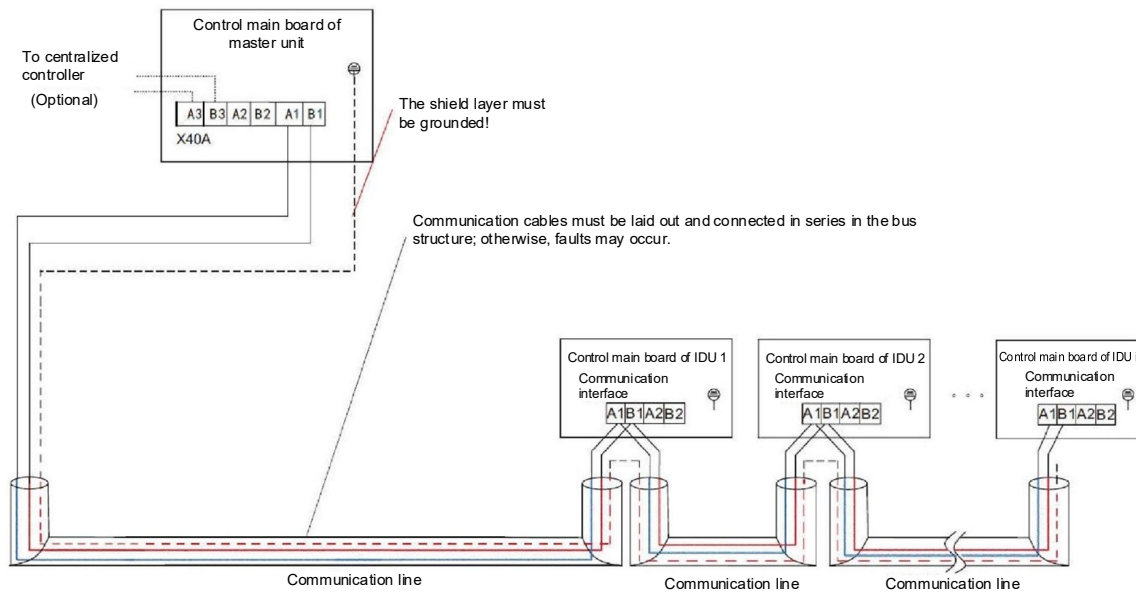

ODU Control Panel

Main board in old version

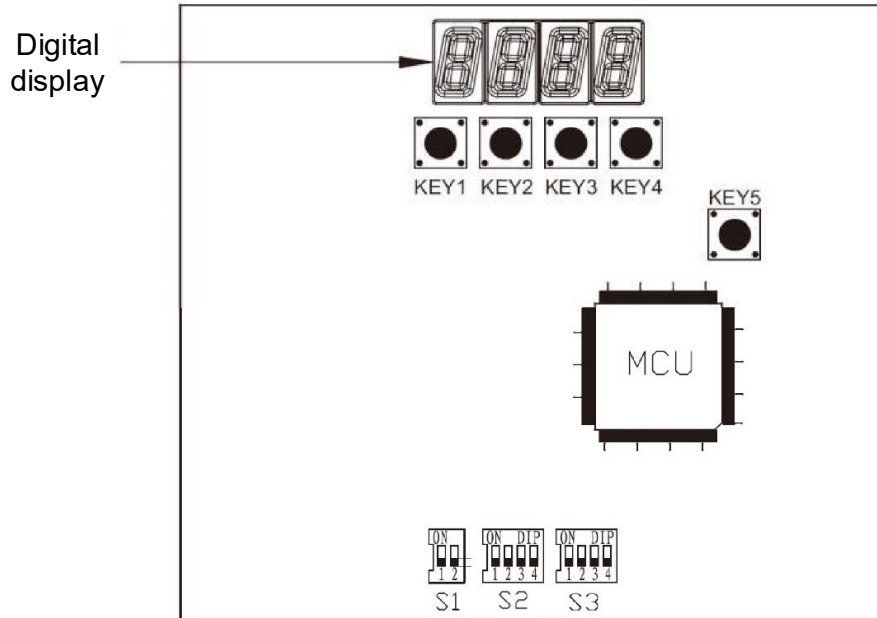

Code settings

Notes:

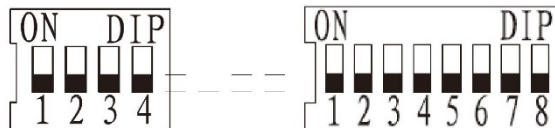

- "0" for the status above, and "1" when dialed to the "ON" position.
- Description of ODU address setting: based on the specific situation after installation is completed.
- The unit must be powered on again after the DIP switch is reset..
- The ODU capacity code has been set properly before delivery. Please check whether the setting is correct.

ODU Control Panel

DIP switch: S1 is 2-bit, S2 is 4-bit, and S3 is 4-bit

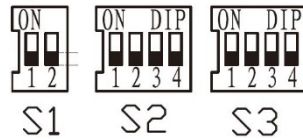

- S1: ODU capacity code (reserved), on need to dial at present
- S2: System configuration DIP switch

No.	Function	Dialed to "0"	Dialed to "1"
S2-1	Master unit/slave unit	Slave unit	Master unit

Remarks: When there are not any modules in series, DIP switch must be "1".

- S3: DIP switch of ODU capacity

Model	S3			
	1	2	3	4
8 HP 252	0	0	0	1
10 HP 280	0	0	1	0
12 HP 335	0	0	1	1
14 HP 400	0	1	0	0
16 HP 450	0	1	0	1
18 HP 504	0	1	1	0
20 HP 560	0	1	1	1
22 HP 615	1	0	0	0
24 HP 680	1	0	0	1
26 HP 730	1	0	1	0
28 HP 785	1	0	1	1
30 HP 850	1	1	0	0
32 HP 900	1	1	0	1
34 HP 950	1	1	1	0

For example, if ODU capacity is 16 HP, DIP switch of S3 is 0 1 0 1. Please refer to the figure for specific positions of DIP switch:

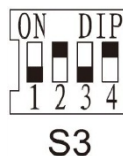

Main board in new version

DIP switch: S1 is 8-bit, S2 is 6-bit, and S3 is 6-bit

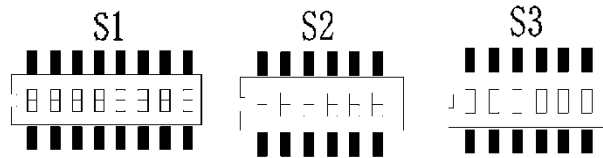

- S1: DIP series switch

Meaning/DIP switch	S1-5	S1-6	S1-7	S1-8
CST/ CSA (8HP-22HP)	0	0	0	0
CXT/ AXA (8HP-22HP)/ AXAT	0	0	0	1
CSA	0	0	1	0
CXA/ AXA(24HP-34HP)	0	0	1	1
CXC	0	1	0	0
CSRYA	0	1	0	1
CXRYA	0	1	1	0

- S2: system configuration DIP switch, unit defaulted to master unit; factory default

S2-1	S2-2	S2-3	S2-4	S2-5	S2-6	Number of slave units	Addresses of slave units
1	0	0	0	0	0	0	/
1	0	1	0	0	0	1	/
1	1	0	0	0	0	2	/
1	1	1	0	0	0	3	/
0	0	0	0	0	0	/	1
0	0	1	0	0	0	/	2
0	1	0	0	0	0	/	3

- S3: DIP switch of ODU capacity

Model	S3					
	S3-1	S3-2	S3-3	S3-4	S3-5	S3-6
8 HP 252	0	0	0	0	0	1
10 HP 280	0	0	0	0	1	0
12 HP 335	0	0	0	0	1	1
14 HP 400	0	0	0	1	0	0
16 HP 450	0	0	0	1	0	1
18 HP 504	0	0	0	1	1	0
20 HP 560	0	0	0	1	1	1
22 HP 615	0	0	1	0	0	0
24 HP 680	0	0	1	0	0	1
26 HP 730	0	0	1	0	1	0
28 HP 785	0	0	1	0	1	1
30 HP 850	0	0	1	1	0	0
32 HP 900	0	0	1	1	0	1
34 HP 950	0	0	1	1	1	0

ODU Control Panel

Settings of relevant keys

1. Contents to be set

- (1) SP03: setting of addresses of equipment for centralized monitoring;
- (2) SP04: setting of centralized monitoring of baud rate;
- (3) SP05: setting of models (TIMS-S/ST/SA/SRYA models and TIMS-X/XA models)
- (4) SP06: fan operating mode (auto quiet mode, smart quiet mode, and forced quiet mode);
- (5) SP07: compressor drive (hardware) configuration;
- (6) SP08: fan drive (hardware) configuration;
- (7) SP09: compressor model configuration;
- (8) SP10: fan model configuration.

2 Buttons and corresponding labels

Buttons: KEY1, KEY2, KEY3, KEY4, KEY5.

Shown icons:

- (1) dP04 : Parameter setting function No.
- (2) SP** : indicates parameter number, where ** indicates specific parameter number (01, 02.....07, 08).
- (3) Ar** : indicates addresses of equipment for centralized monitoring, where ** indicates specific address (01, 02..... 07, 08).
- (4) b*** : indicates centralized baud rate, where *** indicates specific address (12, 24, 48, 96, 192), which is corresponding to the baud rate of 1200, 2400, 4800, 9600 and 19200 respectively.
- (5) Sn** : Sn00: indicates TIMS-S/ST/SA/SRYA models; Sn01: indicates TIMS-X/XA models.
- (6) qoFF : close fan mode selection; auto-quiet mode
qon2: smart quiet mode; qon3: forced quiet mode.

ODU Control Panel

Settings of relevant keys:

Contents

3. Description of specific operations

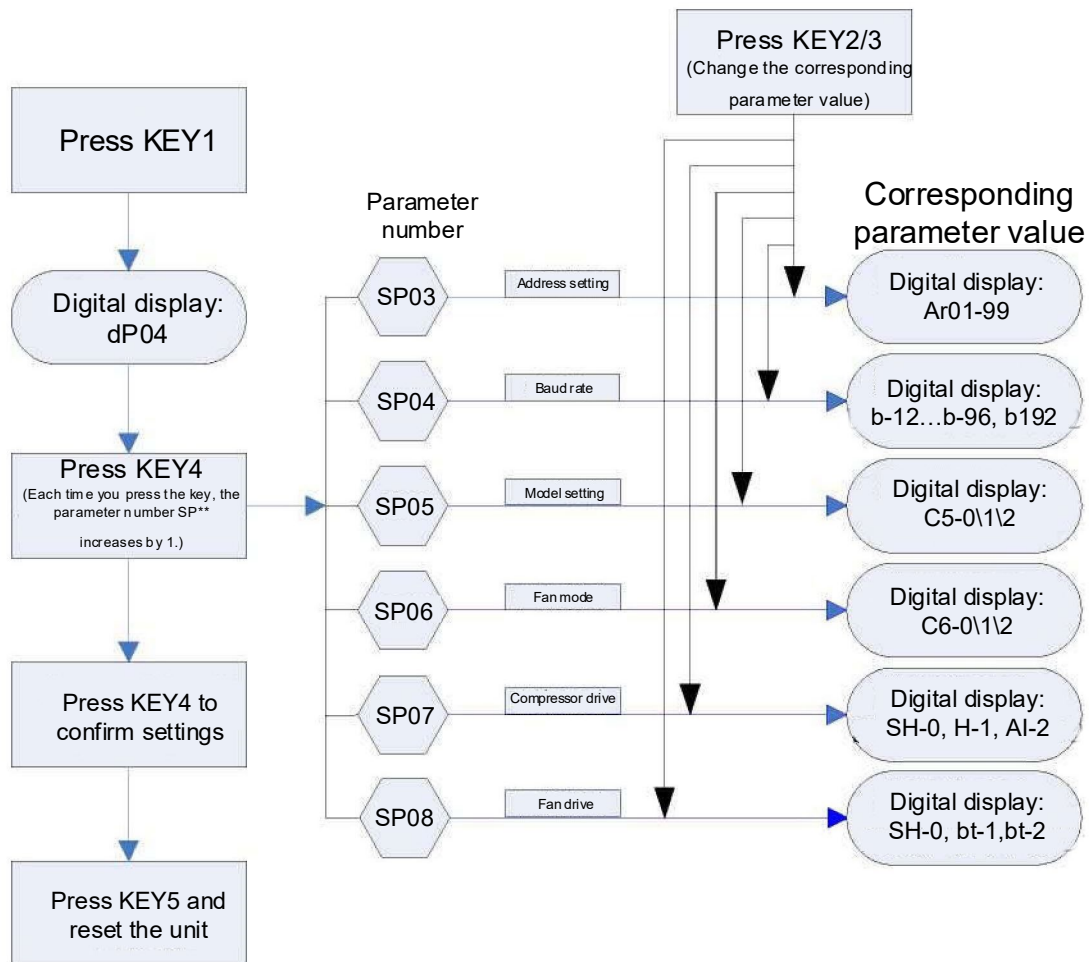

ODU Control Panel

Digital display

- Description of contents showed on the digital display

Note:	0	1	2	3	4	5	6	7	8	9
Digital display	0	1	2	3	4	5	6	7	8	9
Note:	A	B	C	D	E	F	G	H	I	J
Digital display	A	b	C	d	E	F	9	H	I	J
Note:	L	N	O	P	R	S	T	U	Y	
Digital display	L	N	O	P	R	S	T	U	y	

When operation mode varies, N digital display will show the new mode correspondingly; normally it will display this mode for 5s before displaying real-time clock; in the case of malfunctions, it will display the current malfunction code.

- Table of fault codes of digital display:

Code	Content	Handling by the Machine
E000	Disconnection of INV1 high pressure switch	ODU stops
E001	FAN1 drive fault	1# compressor stop
E002	INV1 drive overload	1# compressor stop
E003	INV1 discharge temperature too high	1# compressor stop
E004	INV1 drive communication fault	1# compressor stop
E005	FAN1 drive communication fault	1# compressor stop
E006	INV1 drive overheat fault	1# compressor stop
E007	INV1 drive fault	1# compressor stop
E008	THo1 fault of ambient temperature sensor	ODU stops
E009	THo2 fault of 1 # compressor discharge temperature sensor	1# compressor stop
E010	THo3 fault of suction temperature sensor	Protection runs
E011	THo4 fault of inlet temperature sensor at the auxiliary side of plate heat exchanger	Protection runs
E012	THo5 fault of outlet temperature sensor at the auxiliary side of plate heat exchanger	Protection runs
E013	THo6 fault of outlet temperature sensor at the main side of plate heat exchanger	Protection runs
E014	THo7 fault of temperature sensor of defrosting temperature point	ODU stops

ODU Control Panel

Code	Content	Handling by the Machine
E015	Tho8 fault of 2# compressor discharge temperature sensor	2# compressor stop
E016	1# compressor top temperature sensor FCo1 fault	1 # compressor stop
E017	2# compressor top temperature sensor FCo2 fault	2# compressor stop
E018	Master and slave unit 1 communication fault	/
E019	Master and slave unit 2 communication fault	/
E020	Abnormal capacity distribution between IDU and ODU	ODU stops
E021	Low pressure sensor fault	ODU stops
E022	High pressure sensor fault	ODU stops
E023	phase loss or reverse phase of the power supply	ODU stops
E024	Disconnection of INV2 high pressure switch	ODU stops
E025	FAN2 drive fault	2# compressor stop
E026	INV2 drive overload	2# compressor stop
E027	INV2 discharge temperature too high	2# compressor stop
E028	INV2 drive communication fault	2# compressor stop
E029	FAN2 drive communication fault	2# compressor stop
E030	INV2 drive overheat fault	2# compressor stop
E031	INV2 drive fault	2# compressor stop
E032	Insufficient pressure difference	ODU stops
E033	INV1 discharge superheat degree is too high or too low	Restart running 30 minutes after the ODU stops
E034	High voltage is too low	ODU stops
E035	Low voltage is too low	ODU stops
E036	INV2 discharge superheat degree is too high or too low	ODU stops
E037	Ambient temperature exceeding limit	ODU stops, and resumes operation when temperature returns to normal
E038	No communication between IDU and ODU	ODU stops
E039	System failure	ODU stops. If low/high voltage overload occurs 3 times in 2 hours, reboot ODU
E104	ODU does not match (parameter settings are inconsistent)	ODU stops
E105	ODU and IDU program versions are inconsistent	ODU stops

ECXX indicates communication failure between IDU and ODU, and EC00 indicates IDU 0#, and EC01 indicates IDU 1#, and so on.

Trial Operation

Before trial operation

Make sure to check:

- Installation
 - ✧ Whether the air conditioning unit can be securely fixed at the site.
 - ✧ Whether the place is well ventilated and large enough for maintenance.
 - ✧ Whether the number of IDUs connected to ODU is allowable.
- Wiring
 - ✧ Whether the insulation for the loop of main power supply is intact. Check insulation status against national regulations.
 - ✧ Whether power cord and communication cable have allowable length.
 - ✧ Whether communication cable and power cord are connected correctly and fastened securely.
- Piping
 - ✧ Whether refrigerant piping is dimensionally correct.
 - ✧ Whether refrigerant piping is correctly connected and has reasonable length.
 - ✧ Whether refrigerant piping and drainage pipe are insulated correctly.
- Code
 - ✧ Whether the codes for capacity of control panel for IDU and ODU, and for addresses are correct and set with corresponding numbers (S1, S2 and S3...).

Trial operation

- ✧ Open all the stop valves completely;
- ✧ Connect the power supply:

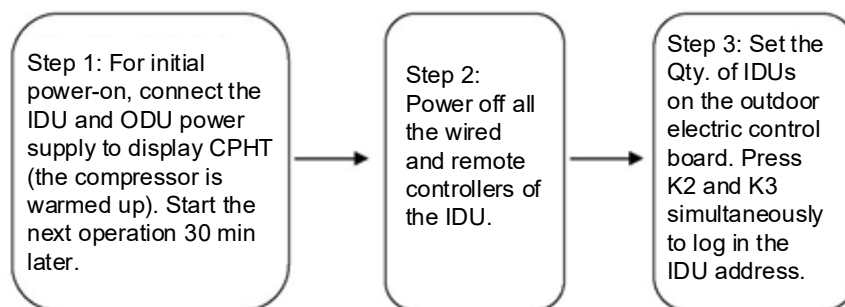

- ✧ Communication check: Observe whether communication indicator light of the ODU flashes regularly. The 4-digit eight-segment digital display shows the clock. If the digital display shows malfunction, please check whether IDU and ODU circuit board codes are right and communication line is correctly connected.

Trial Operation

Trial operation check

Start cooling or heating operation using a wired controller or remote controller.

- After 5 minutes, check whether there is cold (hot) air from IDU.
- Check all the IDUs in the same way.
- If any wiring or piping errors are found, please correct the errors and start trial operation again.

Notes:

- Start another IDU one minute before the current IDU stops, which could save trial operation time.
- Please refer to the following allowable operation range under various operation modes. The system cannot operate normally if exceeding limits.

Mode	Outdoor ambient temperature
Cooling	-5°C to +56°C (DB)
Heating	-27°C to 26°C (WB)

Description of Hazardous Substances

Environmental protection description

This product complies with the environmental protection requirements of the Measures for the Administration of the Restricted Use of the Hazardous Substances Contained in Electrical and Electronic Products.

Environmental protection service life: In the environmental protection service life, the user's normal use of this product will not cause serious pollution to the environment or cause serious damages to persons and properties. The service life is specified by TICA. The environmental protection service life is not equivalent to the service life of safe use.

Recycling: When this product is not needed or its service life ends, recycle it according to the related national regulations on recycling of waste electrical and electronic products. Do not discard it at will.

Names and content of hazardous substances in products

Part name	Hazardous substance					
	Plumbum (Pb)	Mercury (Hg)	Cadmium (Cd)	Hexavalent chromium (Cr(VI))	Polybrominated Biphenyl (PBB)	Polybrominated Diphenyl Ethers (PBDE)
Compressor and its accessories	×	○	×	○	○	○
Refrigerant	○	○	○	○	○	○
Motor	×	○	○	○	○	○
Heat exchanger	×	○	×	○	○	○
Pipeline fittings and valves	×	○	○	○	○	○
Screws, bolts, and other fasteners	○	○	○	×	○	○
Other metal parts	×	○	○	×	○	○
Controller and electrical components	×	○	○	○	○	○
Sponge	○	○	○	○	○	○
Foam	○	○	○	○	○	○
Rubber parts	○	○	○	○	○	○
Electric heating components	×	○	○	○	○	○
Other printed matters	○	○	○	○	○	○

This table is prepared according to the provisions of SJ/T 11364.

○: It indicates that the content of this hazardous substance in all homogeneous materials of the component is below the limit specified in GB/T 26572.

×: It indicates that the content of the hazardous substance in at least one homogeneous material of the component exceeds the limit specified in GB/T 26572, and cannot be replaced for technical reasons. This problem will be gradually solved with the progress of technology.

*: It indicates that the environmental-protection service life of the battery matched with the product is 2 years.

The number in this identification indicates that the environmental protection service life of the product under the normal use status is 15 years. Some parts may also have the identification of environmental protection service life, and their environmental protection service life is subject to the number in the identification. The product configuration may be different due to different models or product improvements. The actual configuration of sold products should prevail.



Follow the Official Site
of TICA PRO LLC
www.tica.ru

«TICA PRO» LLC

Tel.: +7 495 127 79 00, +7 969 190 85 85

E-mail: info@tica.pro

www.tica.ru
